

ROUND BALERS

VARIABLE, FIXED AND COMBINATION



JOHN DEERE



EUROPEAN QUALITY GOES GLOBAL

Our round balers: efficient and easy to operate. Built by a team of Ag experts and engineers in Arc-lès-Gray, France.





Our baler design is driven by global insight. Our manufacturing expertise has a tradition of over 60 years. Our 350,000 global customers love that.

Welcome to our range of variable, fixed and combination chamber round balers. Whether you are looking for sophistication or simplicity, you can now have the baler that's perfect for you and your operation.



CONTENTS

Range and choice	4
Quality and reliability.....	6
Variable	
G and M Series Baler Overview	8
V451G	10
V451M, V461M	14
R Series Baler Overview	18
V451R, V461R	20
Fixed	
M and R Overview	24
F441M	26
F441R	28
Combination	
Fixed Chamber Combination Overview	30
C441R	32
Variable Chamber Combination Overview.....	34
C451R, C461R	36
Crop packaging solutions	38
Connected Farm Management.....	39
Specifications	40

DEDICATED TO VERSATILITY

RANGE AND CHOICE

Whether you are a contractor with a diverse set of customers, or if your own operation's size and structure requires versatility, we've built a baler just for you. Whether you produce straw, hay, haylage or silage – a lot of one, or some of everything, you can pick your winner here.



Productivity



Straw



Hay



Silage



F441R

High capacity. Heavy duty design.

- Built for high volume use
- Premium specification
- Excellent in all crops



C441R/C451R/C461R

Performance in every detail

- Highly productive baler and wrapper combination
- Capability to bale all crops
- Durable construction



V451G

Easy and economical. Simple and robust.

- Ideal for regular use
- Excellent value
- Performs best with dry crops



F441M

Multicrop versatility. Efficient operation.

- Low to frequent, versatile use
- High specification build quality
- Multicrop performer
- Baler chamber choice



V451M/V461M

Multicrop versatility. Efficient operation.

- Regular to frequent, versatile use
- High specification build quality
- Multicrop performer
- 1.65/1.85 m max. bale diameter



V451R/V461R

High capacity. Heavy duty design.

- More than 30 tonnes/hour in straw
- Proven extra high density
- Premium specifications
- Excellent for all crops

RAISE YOUR EXPECTATIONS

QUALITY AND RELIABILITY



We never stop working to keep our balers ahead of the field. Welcome to one of the most productive and rewarding baling experiences available today.



MORE BALE WEIGHT

- 1.2 m bale chamber width
- Very high bale density – adjustable



MORE CROP QUALITY

- From 40 mm knife spacing
- Individually protected, double heat treated knives
- Exceptionally low ground pressure and soil compaction



MORE PRODUCTIVITY

- High capacity pickup
- Industry-leading feeding system
- 40 rpm wrapping arm speed



MORE ROBUSTNESS

- Oversized bearings, optimally sealed
- Cast T-shape gearbox teamed with simple driveline
- High spec materials: Hardox® steel rotor tynes



MORE OPERATIONAL UPTIME

- Superb in all crop conditions
- Excellent unplugging system
- Minimal maintenance, easy installation

Hardox® is a trademark of the SSAB group of companies.



COMPACT BALERS, BIG VALUE

G AND M SERIES BALERS OVERVIEW

The G and M Series balers will always rise to the occasion, especially in dry crops such as hay and straw. Robust and compact, great for the majority of crops and conditions.



1 | FEEDING SYSTEM

Wide, high capacity, high performance pickups let you bale heavy windrows faster.

2 | ROTOR

High Capacity Rotor: 480 mm diameter converging auger, welded on rotor tube for max intake performance without plugging.

3 | CHAMBER SIZE

Adjustable bale diameter in a 1.2 m bale chamber width for maximum bale weight.

6 | SIMPLIFIED DRIVELINE

T-shaped main gear box drives only 4 chains – straightforward design to facilitate quick and easy maintenance.

7 | NET SYSTEM

Easy to install from ground level, net rolls are switched out in less than a minute without tools.

8 | TYRES

Wide flotation tyres minimise soil compaction and damage.



YOUR BUSINESS, YOUR CHOICE

Whether you choose a G or an M Series baler – you're picking a winner that's perfect for your specific requirements.

4 | CHAMBER TECHNOLOGY

Three powered fixed rolls and large diameter belt driving roll for exceptional multicrop performance.

5 | HEAVY DUTY MATERIALS

High spec materials featuring components like Hardox® wear plate tynes, for exceptional reliability.

9 | EASY MAINTENANCE

Excellent access and easy maintenance features like long greasing intervals and chain auto-lube system.

10 | LOWER COSTS

High density bales that stay in shape.

ROBUST AND STRAIGHTFORWARD

V451G



The V451G will always rise to the occasion. A reliably steady, low volume, day to day use performer, it will step up to speedy, high capacity performance.

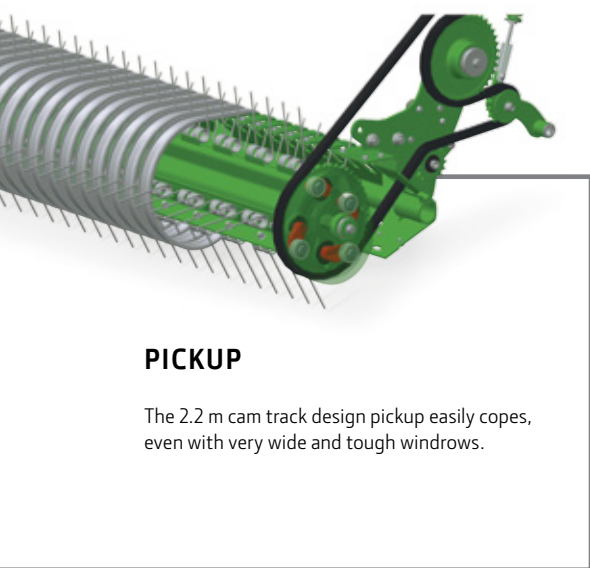

PICKUP

The 2.2 m cam track design pickup easily copes, even with very wide and tough windrows.

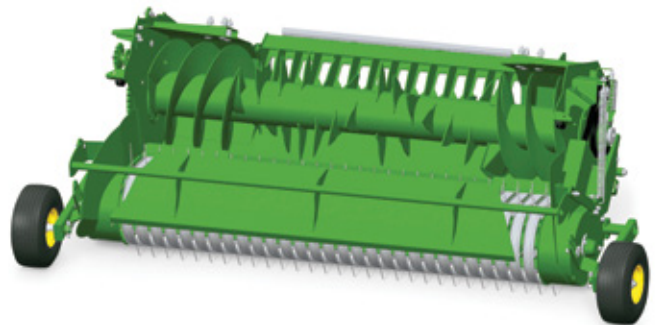

Rust-resistant galvanised pickups with Hardox® rotor tynes for extra durability.



We assembled all greasing points in centralised banks for easy access. The automatic chain lubrication system is standard.

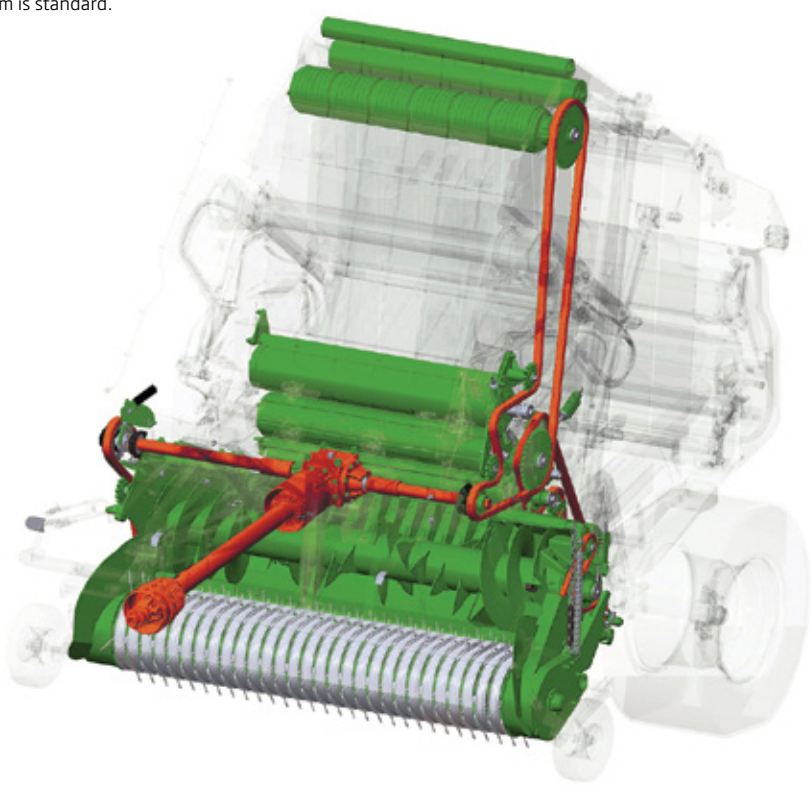

Less is more. The straightforward design with only 4 chains means exceptional durability.



FROM GOOD TO GREAT

V451G

Like every variable chamber baler, the V451G baler features a formation chamber with flat belts and a belt tensioner, but that's where good ends and great begins: An extra heavy duty welded frame that's built for the long haul, a feeding system with a larger diameter pickup for thorough, speedy pickup, plus a specially designed bale chamber for superior control of bale dynamics.

HEAVY DUTY COMPONENTS

50 mm bearings with enhanced seal protection for extended machine life and peace of mind.



Versatile bale chamber technology for the G and M Series.

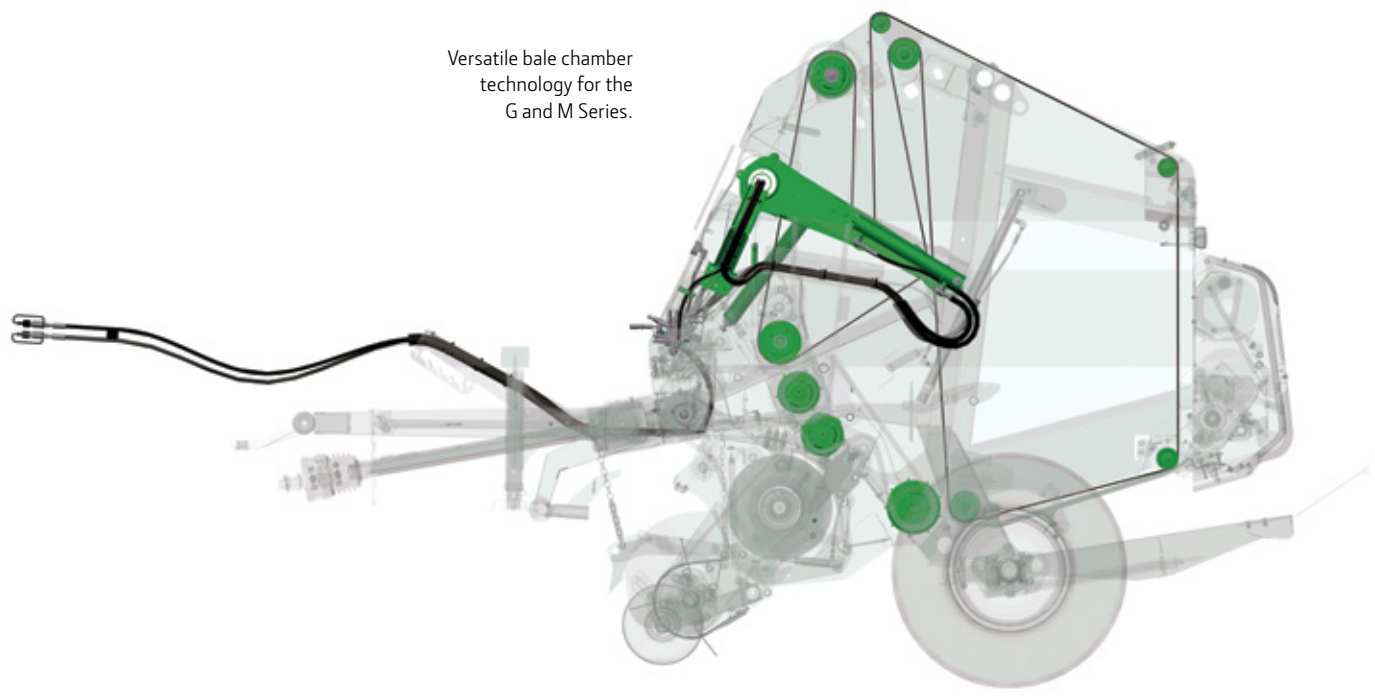

EASY BALE STARTING

Reliable, easy bale starting no matter which crop you're baling.

PROVEN BELT SYSTEM

Six belts with perfect tracking for all crops and conditions. Lacers allow quick in-field repair.

HIGH BALE WEIGHT

1.65 m maximum bale diameter in a 1.2 m wide chamber allows you to maximise bale weight for straw or hay.

STANDARD SOFTCORE SYSTEM

Keeps the bale centre soft, which allows the crop to breathe and dry more efficiently.

EVEN TENSION

High density for every bale diameter thanks to a dedicated, independent pair of density cylinders.

MULTICROP VERSATILITY. EFFICIENT OPERATION.

V451M, V461M



True multi-crop baling where speed is essential. Packed with features it's a high value package that will perform reliably, year after year.

Available as an option for the most demanding users, the five-tyne bar premium 2.2 m pickup features 6 mm diameter tynes, tubular tyne bars and stainless steel strippers to deliver peerless performance over a long life.

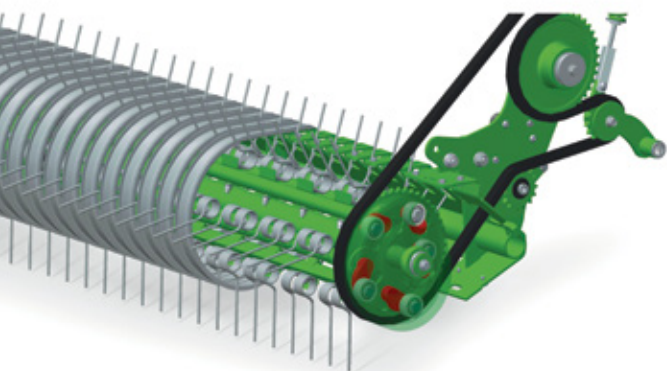

ROTORS – YOUR CHOICE

RotoFlow HC Premium is a rotary feeder with durable Hardox® tynes for even crop distribution, wet or dry. MaxiCut HC 13 Premium is a universal solution for silage, with Hardox® tynes on the rotor that sweep the crop against the individually spring loaded 80 mm spaced knives. Standard with MaxiCut HC 13 Premium, a second large diameter belt driven roll facilitates bale rotation in wet grass silage conditions. Also available as an option with RotoFlow HC Premium.



DROP-FLOOR

The standard drop-floor unplugging system uses a parallelogram mechanism to eliminate clogging on converging augers.

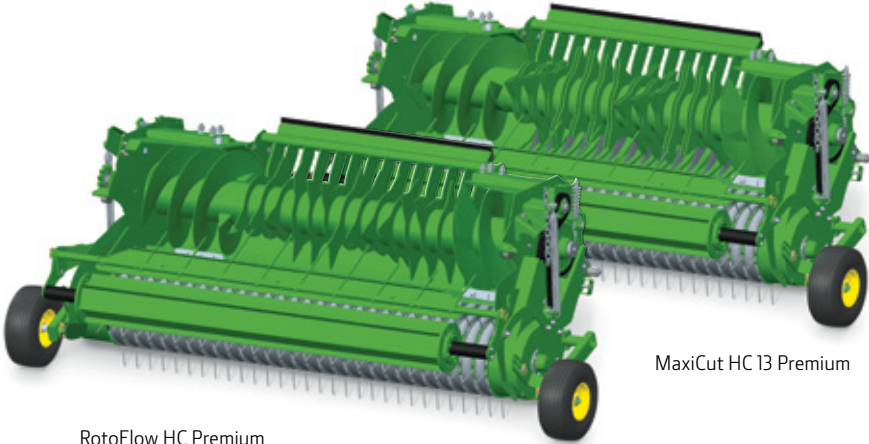
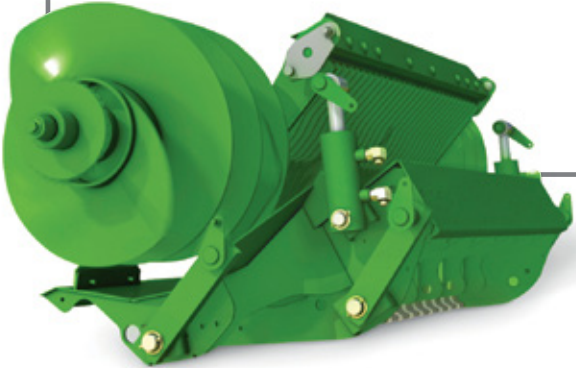

RotoFlow HC Premium

MaxiCut HC13 Premium

STAY FOCUSED

V451M, V461M

Days can get long during the baling season and there is no time to waste. That's why we have integrated several convenience features that allow you to focus on what counts: producing perfect bales as quickly as possible.



MONITOR CHOICES

The V451M/V461M can be operated and controlled with a wide range of available monitors, such as BaleTrak™ Plus or Implement Display 1100. For even more convenience, choose from our ISOBUS compatible monitors.

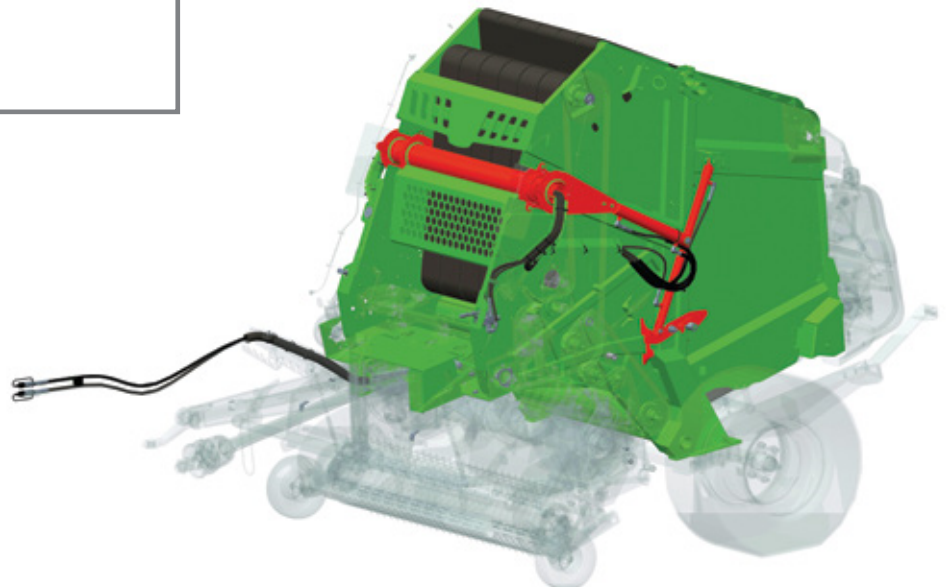

In the V451M and V461M, a dedicated pair of cylinders applies force to the density arm while mechanical hooks firmly lock the tailgate in the closed position. Damper cylinders minimise shocks at the end of the motion.



Automatic greasing by cartridge is available as an option. All greasing points are centralized on a bank as standard.

Easy to install from ground level, net rolls are switched out in less than a minute without tools. Even in the dark – bright, integrated LED lighting makes working at night just as comfortable as during daylight hours.

THE ELEMENTS OF EXCELLENCE

R SERIES BALERS OVERVIEW

High volume, high quality, premium features. The R series balers mean business, with the highest specifications available.



1 | FEEDING SYSTEM

High capacity, high performance 2.2 m wide feeders let you bale heavy windrows faster.

2 | DROP-FLOOR

Hands-free unplugging. The wide hydraulic drop-floor clears even the worst blockage with ease.

3 | BALE CHAMBER

3 powered fixed rolls and 2 large diameter belt drive rolls inside the chamber for top performance.

6 | DRIVELINE POWER

The integrated driveline with its T-shape gear box delivers up to 134 kW (180 hp) for maximum power and speed.

7 | NET SYSTEM

Easy to install from ground level, net rolls are switched out in less than a minute without tools.

8 | FLOTATION TYRES

Choice of tyres up 600/50-22.5 are available to minimise soil compaction and damage.



TRUE MULTICROP VERSATILITY

No matter what crop you are baling, or how much of it – the R Series balers have it all covered. Heavy duty design and premium specifications make sure of it.

4 | TOP SPEED

Less than 5 seconds to unload a bale and close the rear curtain means more than 2 bales per minute.

5 | HEAVY DUTY

Five tubular pickup tyne bars mounted on sealed ball bearings, HD Diamond Chains, Hardox® wear plate rotor tynes and stainless steel pickup strippers.

9 | EASY MAINTENANCE AND ACCESS

Monobloc side gullwing doors with lights, automatic bearing greasing and chain auto-lube systems, crop accumulation prevention.

10 | HIGH DENSITY

As verified in a third-party test by DLG, the density can reach close to 130 kg/m³ in very dry straw conditions.

BALE IN THE FAST LANE

V451R, V461R



Add a lot more bales to your day, even if you call it a day a little earlier – our revolutionary Fast Release System (FRS) in conjunction with the high capacity feeding system makes it possible, to the tune of more than 120 bales per hour. Available with either the MaxiCut™ HC 25 Premium, the MaxiCut HC 13 Premium or RotoFlow HC Premium feeding systems, the V451R and V461R feature a full frame design in which the belts are linked to the frame, not the bale chamber. The independent MaxD bale chamber sits inside the frame so that its sides can move and slide out to create the fastest release system we've ever built.

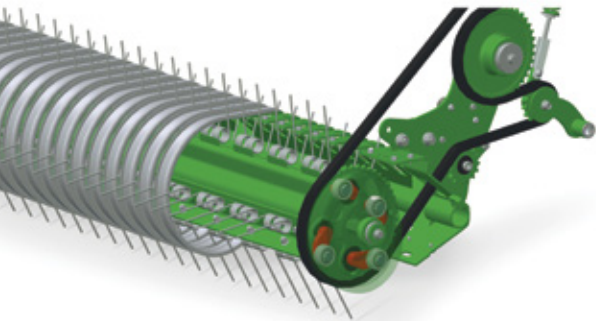

PREMIUM PICKUP

The five-tyne bar 2.2 m heavy duty pickup delivers top tier productivity for large operations.

Select from a choice of high capacity premium rotors – non-cutting or cutting, with various knife sets and spacings from 40-80 mm.

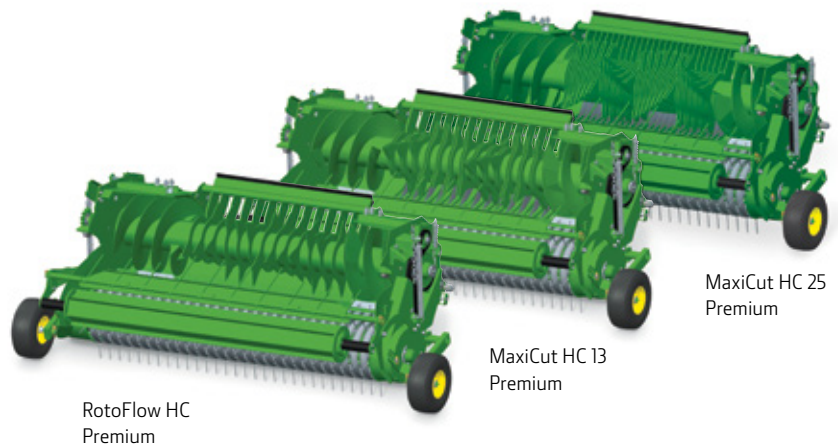

RotoFlow HC Premium

MaxiCut HC 13 Premium

MaxiCut HC 25 Premium





STAY SEATED

Fully control the V451R and V461R balers from the convenience of your cab with ISOBUS displays.



Two 576 mm wide endless belts provide high density and perfect bale coverage for all crops. A high efficiency belt tracking system ensures perfect belt guidance under any conditions. Three chamber rolls ensure perfect bale turning regardless of crop moisture content.

HIGH SPEED DENSITY

V451R, V461R

Rock-hard, super-dense and perfectly formed round bales of concentrated energy. That's what our variable chamber balers churn out, day after day, season after season.



5 SECOND UNLOADING – THREE TIMES FASTER

Featuring high speed tailgate cylinders and moving side sheets that stretch the bale chamber by 100 mm when unloading, these balers save one whole minute for every six bales.



STRESS-FREE OPERATION

The V451R and V461R balers come with Tractor Baler Automation as standard. This award-winning feature allows monitoring, regulating and coordinating baler functions from a tractor equipped with Tractor Implement Automation via the ISOBUS connection. Essential for stress-free operation during high-speed baling.

Fully automated baling process

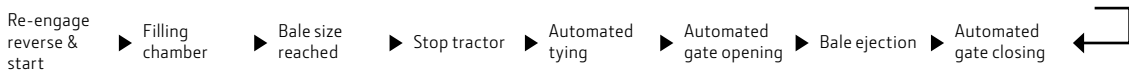



Overall, the round baler was able to convince by delivering a high bale density, a high throughput and a very homogeneous and cylindrical bale form, even for bales with a lower density. The uniform and symmetrical bale density distribution contributes to a good forage quality for silage bales.*

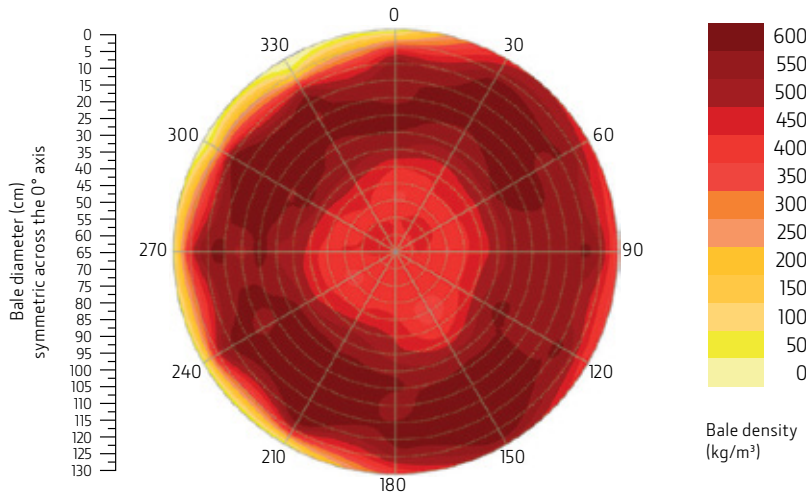

Date:	June 23, 2012
Harvested crop:	Grass silage
Bale number:	12
Bale weight:	786 kg
Bale density:	505.8 kg/m ³
Bale diameter:	127 cm
Bale width:	123 cm
Dry matter content:	68.8%
Density setting:	100%
Number of knives:	13
Driving speed:	14.3 km/h

*DLG Test Report 6112F, April 2013

TOP-TIER TECH INSIDE

M AND R OVERVIEW

Here's your opportunity to benefit from the speed and reliability of the industry's leading baling technology. These balers include many core components and features from our top-of-the-line balers.



1 | FEEDING SYSTEM

Wide, high capacity, high performance pickups let you bale heavy windrows faster.

2 | DROP-FLOOR

Hands-free unplugging. The parallelogram mounted wide drop-floor clears even the worst blockage with ease.

3 | CHAMBER SIZE

1.25 m to 1.35 m adjustable bale diameter in a 1.21 m bale chamber width for maximum bale weight.

6 | SIMPLIFIED DRIVELINE

The integrated driveline, teamed with T-shape gearbox, delivers up to 156.5 kw (210 hp) to maintain field speed even in tough conditions.

7 | NET SYSTEM

Easy to install net rolls are switched in less than a minute without tools.

8 | TYRES

Wide flotation tyres minimise soil compaction and damage.

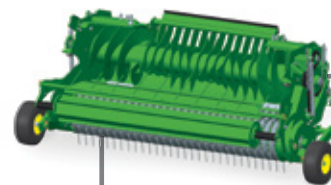

RotoFlow HC Premium:
an excellent multicrop feeder

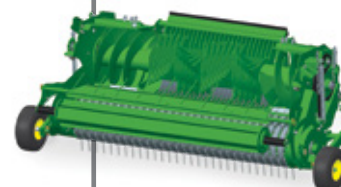

MaxiCut HC Premium:
available with 13 or 25 knives

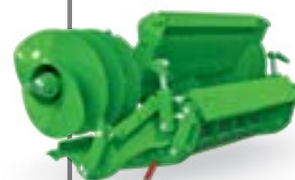

Hands-free unplugging thanks
to the drop-floor

4 | MULTICROP CHAMBER TECHNOLOGY

Available with a conveyor system or with 17 (F441M) or 18 (F441R) 12-rib rollers.

5 | HEAVY DUTY MATERIALS

High spec materials like Hardox® wear plate tynes, oversized bearings and upgraded steel rollers for exceptional reliability.

9 | EASY MAINTENANCE

Excellent access and easy maintenance features like low greasing intervals and chain auto-lube system.

10 | HIGH DENSITY BALES

Our bales are dense and keep their shape even after several handling operations.

EFFICIENT MULTICROP VERSATILITY

F441M



Our F441M is a full-featured, reliable, multicrop performer, ideal for medium volume use or for low volume operations where a narrow time frame means higher capacity and speed is essential.



KEYS TO PERFORMANCE

The pickups are available in widths of 2 m or 2.2 m. Their Camtrack design easily copes even with very wide and tough windrows.

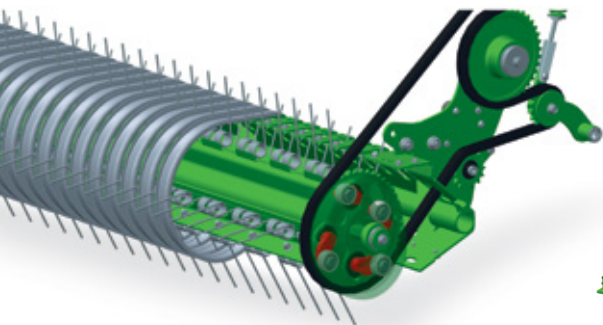

The optional drop-floor unplugging system uses a parallelogram mechanism to eliminate clogging on converging augers.

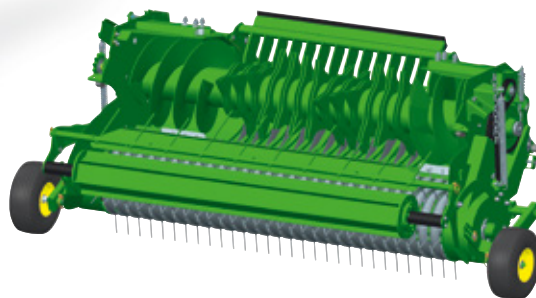

Rust-resistant galvanised pickups with Hardox® tynes for extra durability.



GET CONTROL

From basic net tying control (BaleTrak™ Easy) to full bale management with our BaleTrak monitor.

GET SPECIFIC

To achieve the optimal bale weight for your application, you have the choice between two purpose designed 1.21 m wide chambers.

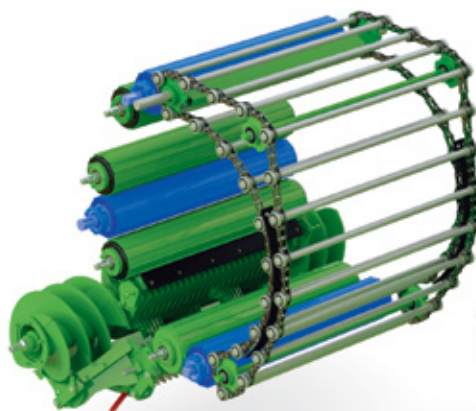

Multicrop – the conveyor system is the ideal solution for multicrop operations.



Silage applications are best served by the roller system with a series of aggressive 12-ribbed rollers.

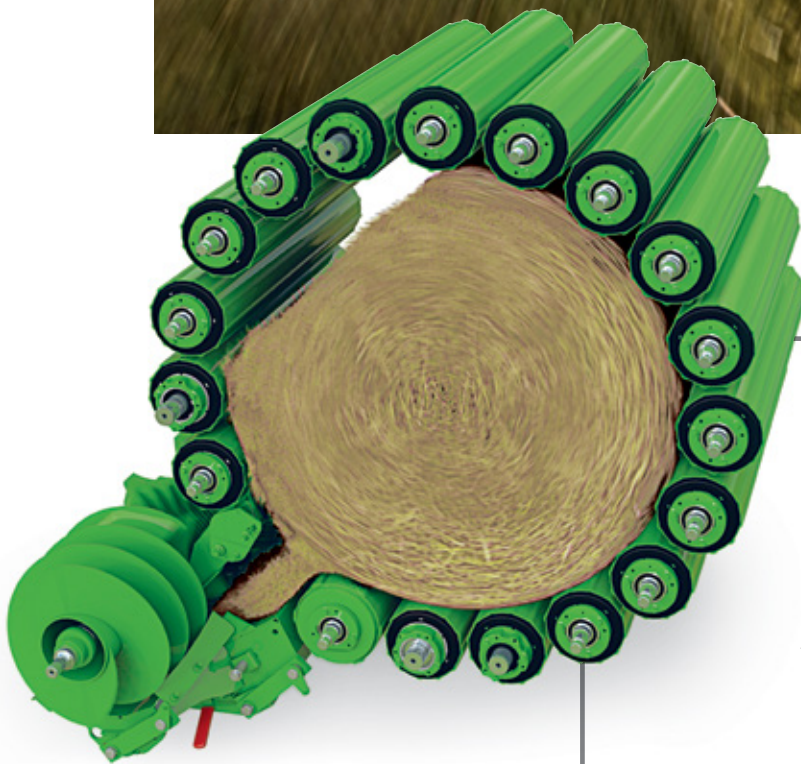

BALE CHAMBER ECONOMICS

The chamber features 18 twelve rib rollers made of high-grade steel. Both bale density and diameter can be set up from the cab through ISOBUS connection.

Heavy duty: Doubled large 50 mm bearings extend the life of your baler.





BIG LEAGUE BALING

F441R



If you are looking for even further output and performance – we've got the baler for you. The F441R: when the baling jobs are big, and you have to get them done quickly. This is the baler with top performance in a heavy-duty design coupled with legendary John Deere reliability. It doesn't get more professional than this.

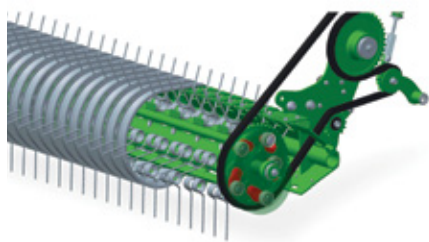

PERFORMANCE BOOST

For peerless performance that lasts, the optional five-tine bar, premium 2.20 m pickup features 6 mm diameter tynes and stainless steel strippers.

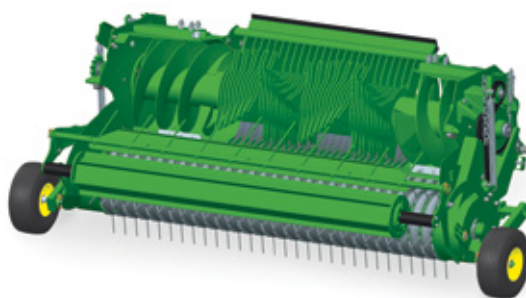

ALL PREMIUM

Our high capacity premium rotors come with Hardox® tynes and 13 or 25 knife cutting versions, with various knife sets and spacings from 40-80 mm.

TOUGHER. FASTER. DONE.

FIXED CHAMBER COMBINATION OVERVIEW

Let's call it total baling. An impressive union of the premium F441R solo baler and the John Deere Table Transport System (TTS) in the ultimate compact wrapping baler. The C441R baler adds high performance wrapping to high capacity baling, with easy ISOBUS control and speedy film replacement.



1 | FEEDING SYSTEM

High capacity, high performance 2.2 m wide feeders let you bale heavy windrows faster.

2 | DROP-FLOOR

Hands-free unplugging. The parallelogram mounted wide drop-floor clears even the worst blockage with ease.

3 | CHAMBER SIZE

1.25 m to 1.35 m adjustable bale diameter in a 1.21 m bale chamber width for maximum bale weight.

4 | SIMPLIFIED DRIVELINE

The integrated driveline, teamed with T-shape gearbox, delivers up to 156.5 kW (210 hp) to maintain field speed even in tough conditions.

5 | HEAVY DUTY

Five pickup tyne bars mounted on sealed ball bearings, HD Diamond Chains and Hardox® wear plate rotor tynes.

6 | TTS

Even in hilly terrain, the Table Transfer System provides efficient bale transfer that preserves bale shape.



7 | NET SYSTEM

Easy to install net rolls are switched in less than a minute without tools.

8 | TYRES

Whether single or tandem axle, for each situation you have the choice between tyres that keep the machine width below 3 m.

9 | QUICK CONVENIENCE

Speedy reloads with our innovative film roll storage system. Easy maintenance access with gullwing style doors.

10 | FAST WRAPPING ARM

40 RPM produces a high wrapping system capacity with maximum productivity of up to 92 bales per hour.



**ALSO AVAILABLE
WITH SINGLE AXLE**

FAST-LANE HARVESTING

C441R



The C441R baler adds high performance wrapping to high capacity baling, with easy ISOBUS control and speedy film replacement.





SECURE TRANSFER

Efficient bale transfer in a fast and smooth process preserves the bale shape. The deep table allows operators to bale in even hilly conditions.

Rapid film roll loading – This John Deere system lets you maintain high productivity levels with fast and easy film roll reloading.



REMAIN SEATED

Operate and control the C441R with the 4240 Universal Display. ISOBUS functionality allows you to easily configure your C441R from inside the cab.



PRODUCTIVITY POWERHOUSE

VARIABLE CHAMBER COMBINATION OVERVIEW

It does not happen often in life, but sometimes you can have it both ways: the C451R/C461R combine the V451R and V461R solo balers with the John Deere Transport Table System (TTS) to create the ultimate wrapping baler.



1 | FEEDING SYSTEM

High capacity, high performance 2.2 m wide feeders let you bale heavy windrows faster.

2 | DROP-FLOOR

Hands-free unplugging. The wide hydraulic drop-floor clears even the worst blockage with ease.

6 | TTS

Even in hilly terrain, the Transport Table System provides efficient bale transfer that preserves bale shape.

7 | NET SYSTEM

Easy to install from ground level, net rolls are switched out in less than a minute without tools.



ADDED VALUE

Everything that makes the V451R and V461R balers stand out, plus high-performance wrapping: meet the C451R and C461R.

3 | BALE CHAMBER

3 powered fixed rolls and 2 large diameter belt driving rolls inside the chamber for true multicrop capacity.

4 | TOP SPEED

Less than 8 seconds to unload a bale and close the rear curtain means higher productivity.

5 | HEAVY DUTY

Five pickup tyne bars mounted on sealed ball bearings, HD Diamond Chains and Hardox® wear plate rotor tynes.

8 | TYRES

Two sets of tyres are available: 500/45-22.5 keep machine width below 3 m and 620/40R22.5 minimise compaction.

9 | QUICK CONVENIENCE

Speedy reloads with our innovative film roll storage system. Easy maintenance access with gullwing style doors.

10 | FAST WRAPPING ARM

40 RPM produces high wrapping system capacity with maximum productivity of up to 92 bales per hour.

ON THE SHOULDERS OF GIANTS

C451R, C461R

The C451R and C461R variable chamber balers are powerful workhorses capable of producing high volumes in those short harvest windows.

The C451R/C461R wrappers feature fast unloading times and a high-speed 40 RPM wrapping arm unit. In conjunction with the high capacity feeding system and our advanced bale chamber technology they'll push your baling capacity way beyond current limits, whether you're baling silage, hay or straw.



RAPID FILM ROLL LOADING

This John Deere system lets you maintain high productivity levels with fast and easy film roll reloading.

FAST RELEASE SYSTEM

The bale chamber unloading system is a critical component in a wrapping baler. John Deere Fast Release System (FRS) boosts overall baler productivity by reducing bale ejection time.



SECURE TRANSFER

The transport table receives the bale and efficiently transfers it to the wrapping system. The deep table guides the bales carefully, preserving their shape, and works flawlessly even on steep slopes.



SIDE CONTROL PANEL

Practical design: you can easily control the table, film storage and knives from the conveniently located side control panel.



GREASING SYSTEM

Our greasing system comes as standard on the C451R/C461R. The 1,200 g capacity tank holds plenty, while greasing is accurately managed from your monitor.

BALE VALUE BOOSTERS

CROP PACKAGING SOLUTIONS

John Deere crop packaging products enhance the performance of your baler, and provide you with the very best John Deere protection for your bales.



B-Wrap

Shed-quality bales without the shed: Outside, our John Deere B-Wrap protects your valuable crop from rain, and helps reduce ground moisture. B-wrap is an exclusive John Deere product.

XtraNet™

Bale all day for less. Designed specifically for your baler, with easy loading system. Strong, long and wide.

CoverEdge™ – THE ORIGINAL

The authentic leading edge protection. The net covers the bale edge, eliminating bale “shoulders”.

The secret behind B-Wrap is an innovative material featuring the SCM technology – keeping a bale dry, and moisture and mould out.

- 1 | Water Vapour Escapes
- 2 | Blocks Ground Moisture
- 3 | Water Resistance
- 4 | UV Protection



John Deere B-Wrap



XtraNet, CoverEdge



OPTIMISING PRODUCTIVITY

CONNECTED FARM MANAGEMENT

The John Deere Operations Center on MyJohnDeere.com is the central platform for connecting your machines, operators and paddocks. It's easy to use, easily accessed from anywhere, on any device and lets you view, edit and share data for full fleet connectivity.

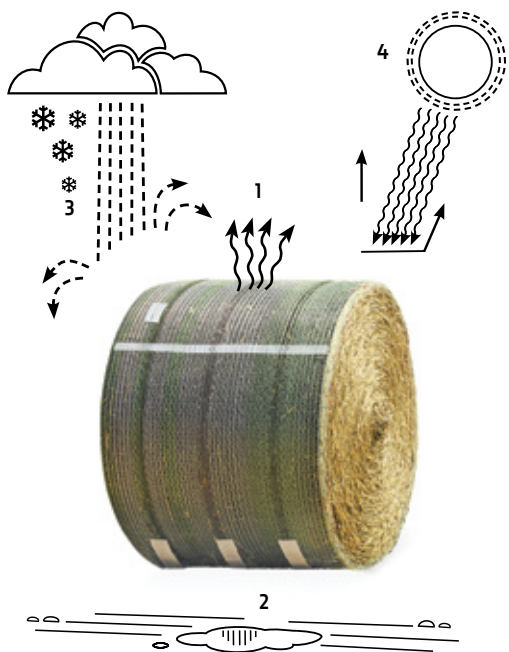

SPECIFICATIONS

	V451G	V451M	V461M
BALES			
Diameter (m)	0.9-1.65	0.9-1.65	0.9-1.85
Width (m)	1.21	1.21	
PICKUP			
Width (m)/(m DIN)	2.20 m (2.12 m DIN)	2.00 m (1.86 m DIN) and 2.20 m (2.12 m DIN)	
Tynes bars	4	4 or 5 (2.20 m only)	
Crop compressor	Compressor shield or Compressor roll (optional)	Compressor shield or Compressor roll	
Gauge wheels	Fixed	Fixed or castor action	
ROTOR FEEDER			
Type / number of knives	RotoFlow HC / No knife	RotoFlow HC Premium / No knife	
	-	MaxiCut HC 13 Premium / 13 knives	
Knife set	-	-	
Unplugging system	Manual wrench + rotor clutch	0/13	
Unplugging system	Manual wrench + rotor clutch	Full width drop-floor with parallel kinematic	
BALE CHAMBER			
Type	6 laced belts + 2 front rolls + starter roll	6 laced belts + 2 front rolls + starter roll	
Bale dumping	Unloading ramp (optional)	Unloading ramp (optional)	
NET BINDING			
Net system	Standard – on baler tailgate Fully adjustable from monitor	Standard – on baler tailgate Fully adjustable from monitor	
Boarding capacity	2 rolls	2 rolls	
B-Wrap	-	Option	
TWINE BINDING			
Twine system	2 independent arms (optional)	2 independent arms (optional)	
Boarding capacity	8 twine spools	8 twine spools	
POWER TAKE OFF			
PTO security	Cam clutch	Cam clutch	
PTO speed and capacity	540 RPM – 102 kW (137 hp)	540 RPM – 113 kW (154 hp)	
DISPLAYS			
Type	BaleTrak™ Easy or BaleTrak (optional)	BaleTrak Plus Implement Display 1100 - ISOBUS baler and No monitor - ISOBUS baler (optional)	
MAINTENANCE			
Automatic chain lubrication	-	Standard	
Grease bank	Standard	Standard	
Automatic bearings greasing	-	Cartridge system (optional)	
TYRES			
Tyre size	15/55-17	15/55-17	
	500/50-17	500/50-17	
	-	500/55-20	
	-	-	
MINIMUM POWER REQUIREMENT			
kW (hp)	75 kW (100 hp)	75 kW (100 hp) no knife – knives not engaged	
		82 kW (110 hp) 13 knives engaged	
		-	

V451R	V461R	F441R	F441M
0.8-1.60	0.8-1.85	1.25-1.35	1.25-1.35
1.21		1.21	1.21
2.20 m (2.12 m DIN)		2.00 m (1.86 m DIN) / 2.20 m (2.12 m DIN) (optional)	2.00 m (1.86 m DIN) / 2.20 m (2.12 m DIN) (optional)
5		5	4
Compressor roll		Compressor Roll (2.00 m/2.20)	Compressor shield (2.00 m/2.20) or Compressor Roll (2.00 m/2.20)
Fixed or castor action		Fixed or castor action (optional)	Fixed or castor action (optional)
RotoFlow HC Premium / No knife		MaxiCut HC13 Premium / 13 knives	RotoFlow HC Premium (no knives)
MaxiCut HC 13 Premium / 13 knives		MaxiCut HC 25 Premium / 25 knives	MaxiCut HC 13 Premium
MaxiCut HC 25 Premium / 25 knives		-	-
0/13 or 0/12/13/25		0/13 or 0/12/13/25	0/13
Full width drop-floor with parallel kinematic		Full width drop-floor with parallel kinematic	RotoFlow HC Premium: manual wrench or full width drop-floor with parallel kinematic (optional) MaxiCut HC 13 Premium: Full width drop-floor with parallel kinematic
2 endless belts + 2 front rolls + starter roll		18 ribbed rolls with 2 reinforced and 2 heavy duty	Multicrop: 7 ribbed rolls (3 reinforced) Silage Special: 17 ribbed rolls (4 reinforced)
Unloading ramp (optional)		Ramp (optional)	Ramp (optional)
Standard – on baler front Fully adjustable from monitor		Base	Standard
3 rolls		2 net rolls (base) + 1 roll (optional)	2 net rolls (base) + 1 roll (optional)
Option		Yes	Yes
2 independent arms (optional)		N/A	N/A
10 twine spools		-	-
Cam clutch		Cam clutch	Cam clutch
540 RPM – 124 kW (166 hp) 1,000 RPM – 136 kW (182 hp) (standard with MaxiCut HC 25 Premium)		1,000 RPM (base) - 157 kW (210 hp) with MaxiCut HC 25 MaxiCut HC 13 (optional) 540 RPM - 124 kW (166 hp)	540 RPM - 120 kW (137 hp)
Implement Display 1100 or Greenstar™ Display 4240 or No monitor		BaleTrak Plus (base) with MaxiCut HC 13 Implement Display 1100 and GreenStar™ 4240- ISOBUS baler (optional) with MaxiCut HC25 No monitor (optional) with ISOBUS baler	BaleTrak Easy or BaleTrak (optional)
Standard		Standard	Standard
Standard		Standard	-
Tank system (optional)		Cartridge (optional) Tank/ISOBUS system (optional)	-
		15/70-18, 16/70-20 (chevron pattern)	19/45-17, 15/55-17, 15/70-18, 16/70-20 (chevron pattern)
500/55-20		500/55-20	500/55-20
520/55R22.5		520/55R22.5	-
600/50-22.5		600/50-22.5	-
75 kW (100 hp) no knife – knives not engaged			
82 kW (110 hp) 13 knives engaged		75 kW (100 hp)	56 kW (75 hp)
89 kW (120 hp) 25 knives engaged			

SPECIFICATIONS

	C441R	C451R	C461R
BALES			
Diameter (m)	1.25-1.35	0.8-1.60	0.8-1.70
Width (m)	1.21	1.21	
PICKUP			
Width (m)/(m DIN)	2.20 m (2.12 m DIN)		2.20 m (2.12 m DIN)
Tynes bars	5		5
Crop compressor	Compressor roll		Compressor roll
Gauge wheels	Fixed, or castor action (optional)		Fixed, or castor action (optional)
ROTOR FEEDER			
Type / number of knives	MaxiCut HC 13 Premium / 13 knives	RotoFlow HC Premium / No knife	
	MaxiCut HC 25 Premium / 25 knives	MaxiCut HC 13 Premium / 13 knives	
Knife set	HC13: 0-13. HC25: 0-12-13-25	MaxiCut HC 25 Premium / 25 knives	
Unplugging system	0/13 or 0/12/13/25		Full width drop-floor with parallel kinematic
Unplugging system	Full width drop-floor with parallel kinematic		Full width drop-floor with parallel kinematic
BALE CHAMBER			
Type	18 twelve ribbed rolls with 4 heavy duty		2 endless belts + 2 front rolls + starter roll
Bale dumping	-		Unloading ramp (optional)
NET BINDING			
Net system	Standard		Standard – on baler front Fully adjustable from monitor
Boarding capacity	2 net rolls (base) + 1 roll (optional)		3 rolls
B-Wrap	-		Option
POWER TAKE OFF			
PTO security	Cam clutch		Cam clutch
PTO speed and capacity	1,000 RPM (base) with MaxiCut HC 25, MaxiCut HC 13 (optional) 540 RPM - 124 kW (166 hp) or 1,000 RPM - 157 kW (210 hp)		540 RPM – 124 kW (166 hp) (base) with MaxiCut HC 13 1,000 RPM – 136 kW (182 hp) (standard with MaxiCut HC 25 Premium, optional MaxiCut HC 13)
DISPLAYS			
Type	GreenStar 4240 display (base) No monitor (optional)		Greenstar Display 4240 or No monitor
MAINTENANCE			
Automatic chain lubrication	Standard		Standard
Grease bank	Standard		Standard
Automatic bearings greasing	Cartridge system (base) Tank/ISOBUS system (optional)		Standard – Tank system
WRAPPING SYSTEM			
Bale transfer	Table Transfer System with optimised speed		Table Transfer System with optimised speed
Wrapping arms	2 arms with optimised speed (up to 40 RPM)		2 arms with optimised speed (up to 40 RPM)
Dumping mode	Automatic or Manual - optional Bale tilt		Automatic or Manual – optional Bale tilt
Film boarding capacity	2 x 750 mm rolls on wrapping arms + 10 rolls storage		2 x 750 mm rolls on wrapping arms + 10 rolls storage
TYRES			
Tyre size	Single Axle: 600/55R22.5, 750/45R22.5		Tandem axle
	Tandem Axle: 500/45-22.5, 620/40R22.5		500/45-22.5
			620/40R22.5
MINIMUM POWER REQUIREMENT			
kW (hp)	82 kW (110 hp) with MaxiCut HC 13		75 kW (100 hp) no knife – knives not engaged
	97 kW (130 hp) with MaxiCut HC 25		82 kW (110 hp) 13 knives engaged
			90 kW (120 hp) 25 knives engaged

YOU NEED THE BALER THAT'S JUST RIGHT FOR WHAT YOU DO.

Every one of these machines represents the uncompromising standards of quality and reliability that make them a John Deere. Choose the one that's perfect for you.



NOTHING RUNS LIKE A DEERE

Chances are that when you need us, you need us right then and there. For advice, to solve a problem, or for a part. Reach out, we'll be there with technicians who are factory trained, ready to go to work for you, using genuine John Deere parts and products.



JOHN DEERE

This literature has been compiled for worldwide circulation. While general information, pictures and descriptions are provided, some illustrations and text may include finance, credit, insurance, product options and accessories NOT AVAILABLE in all countries or regions. In some countries, products and accessories may require modifications or additions to ensure compliance with the local regulations of those countries. PLEASE CONTACT YOUR LOCAL DEALER FOR DETAILS. John Deere reserves the right to change specification and design of all products described in this literature without notice. John Deere's green and yellow colour scheme, the leaping deer symbol, and JOHN DEERE are trademarks of Deere & Company. All photography and illustrations contained herein are copyrighted assets of Deere & Company.

JohnDeere.com.au
JohnDeere.co.nz