



3000 / 4000 / 5000 / 6000

*The Obvious Choice*  
**NAVIGATOR**



# The Obvious Choice

# NAVIGATOR

3000 / 4000 / 5000 / 6000



## **i** for intelligent

To reduce the environmental impact as much as possible by increasing the application precision significantly and make the operation of the sprayer easier and safer for the driver, the NAVIGATOR “i” machines offers you the best intelligent spraying features: The automated cleaning system AutoWash – to make sure to leave no residues in the liquid system or main tank, automated spraying features like AutoNozzleControl to control each nozzle individually for higher precision and faster driving speeds, and the whole new HARDI SmartCom ECU for faster diagnostics – you are well prepared for the future.

### SPECIFICATIONS

- ▶ **Tank:** 3000 / 4000 / 5000 / 6000 l
- ▶ **Track:** IntelliTrack, high performing and stable drawbar steering
- ▶ **Controller:** HC 8600, HC 9600, HC 8700, HC 9700 or ISOBUS
- ▶ **TurboFiller:** Efficient handling of liquid and powder
- ▶ **Liquid system:** DynamicFluid4 for precise application in all conditions
- ▶ **Axle:** Adjustable 1.5-2.25 m
- ▶ **Booms:**  
 DELTA FORCE: For higher speeds and greater performance 21 to 39 m  
 EAGLE: Simple and strong booms 18 to 30 m  
 VPZ: The vertically folded 21 to 28 m

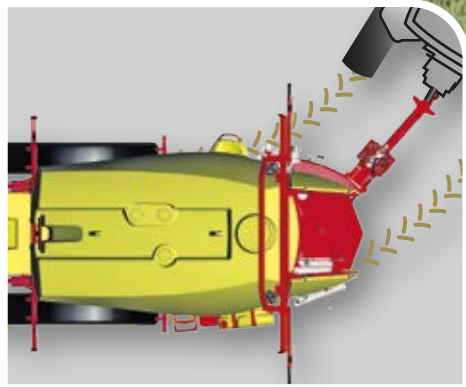

**Perfect tracking**

The tracking concept is easy to connect and operate, ensuring safe tracking even in difficult field conditions.

IntelliTrack has an integrated safety feature which prevents the cylinders from steering the drawbar when the driving speed is too high for the given track width.

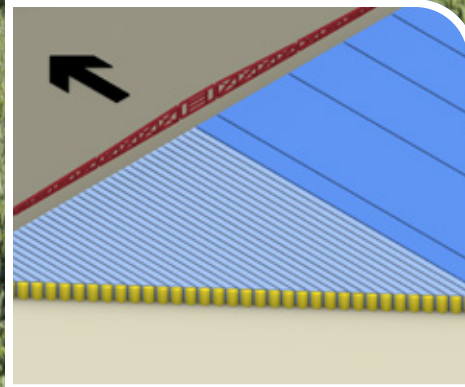

**Save up to 10% liquid**

Minimize double sprayed area thereby saving up to 10% chemicals and avoid crop damage due to double spraying. Get full control of your spray job with the automated nozzle on/off feature AutoNozzleControl. Thanks to the PrimeFlow system, you will receive the highest level of precision, due to the exact control of each nozzle.



**Connect**

Besides offering you a full ISOBUS experience for easy connection of controllers, the HARDI SmartCom will provide quick and easy diagnostics with the HARDI ServiceTool. And due to the faster processing speed, you will experience a faster and very precise regulation system and steering precision. On top of this, cloud connections will prepare you for remote diagnostics.



**Intelligent control of liquid system**

With the NAVIGATOR “i”, a FluidBox is located at the WorkZone in the front. With a functional design, the sprayer operator will be able to quickly start the demanded operation.

- ▶ Easy operation of the SmartValves
- ▶ Control of filling, agitation, spraying and cleaning

# Chassis

*Designed for high-speed driving*

Designed for high-speed driving under the most demanding field and road conditions. The robust NAVIGATOR frame is made of high-tensile steel and is ready to meet the tough demands of the professional farmer.

The concept gives the best compromise between excellent clearance and low centre of gravity.

### Low centre of gravity

The entire NAVIGATOR design has the lowest possible centre of gravity without compromising clearance under the sprayer.

### Unique design with long drawbar

The long drawbar is one straight line from the coupling point to the axle. Being bolted underneath the frame, it ensures good driving stability and absorbs the up-and-down forces at high-speed driving. The drawbar is available as a fixed or as a steering drawbar and in a low or high-hitch version.



### Perfect clearance

The unique design of axle and frame ensures excellent crop clearance, reducing crop damages to the absolute minimum. No brake rods or steering components are lower than the axle.



### SmoothRide suspension

The SmoothRide suspension system is uncomplicated, reliable and requires little or no service. The suspension provides a better ride of the sprayer, ensuring higher capacity and comfort.

### Accurate tracking with user-friendly operation

This high-end steering drawbar concept offers a tight turning radius. A combination of advanced electronics, proportional valve and two large hydraulic cylinders ensures a safe, accurate tracking with user-friendly operation.

### Preventing tilt over

IntelliTrack has an integrated safety feature which prevents the cylinders from steering the drawbar when the driving speed is too high for the given turning radius.

The controller will constantly monitor the forward speed and steering angle width to make sure that the tracking is not used when it is not safe. If the tractor driver attempts a 90° turn at e.g. 15 km/h, the IntelliTrack system automatically computes the data and straightens up the drawbar. These settings are user defined.

When the IntelliTrack has been calibrated, the operator only needs to attach 2 small chains to the tractor, before he can start spraying. Together with the brackets, the two connection chains build a trapeze which tolerates slack forced or drawbar torsion.

For a better stability when turning, the pivot point between trailer and drawbar is angled. This feature helps you minimizing the turning radius down to 6.0 m on the NAVIGATOR 3000 and 4000 and 8.5 m on 5000 and 6000.

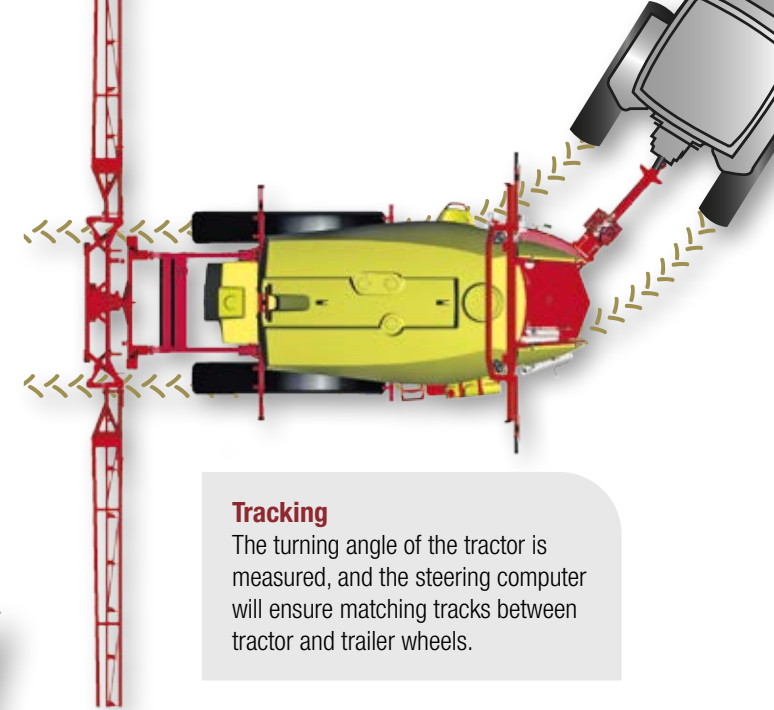

### Tracking

The turning angle of the tractor is measured, and the steering computer will ensure matching tracks between tractor and trailer wheels.

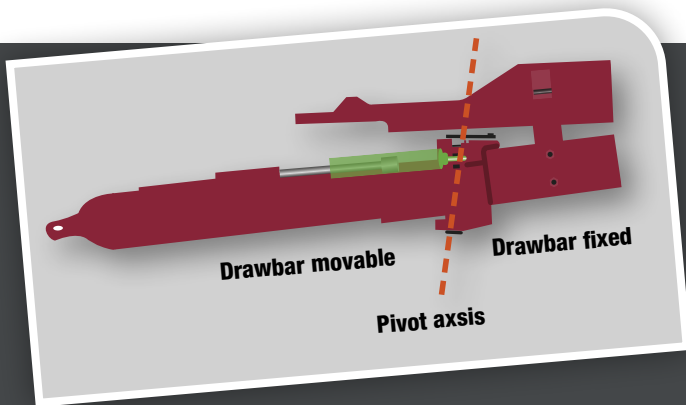

### Safe steering

The steering geometry and the angled pivot axis ensure that the centre of gravity of the trailer is following the gravity curve and minimize the risk of tilt over.

Gravity curve



Weight

NAVIGATOR 60



# WorkZone

## Easy operation

The NAVIGATOR has been designed with a strong focus on user-friendliness and ease of operation, with the WorkZone being a fine example. In this area, everything you need to operate the sprayer is available, with all primary functions placed in easy-to-reach positions. The WorkZone is designed to be simple and logical to operate. For NAVIGATOR "i" versions, the operation of the SmartValves is done remotely from the FluidBox.

### SmartValve

All primary functions needed to operate the sprayer when filling or cleaning are located in the centre of the WorkZone. The logically placed handles with easy to read icons make the system very easy to operate. This greatly reduces the start-up and operation time of the sprayer.

### High mixing capacity

The advanced TurboFiller is one of the best on the market. It is specifically developed to handle large quantities of powders and liquids. Using a combination of high vacuum and powerful rotation inside the hopper, it mixes all types of chemicals quickly and safely. In addition, the TurboFiller is easy to both operate and clean.



### Easy operation

With the NAVIGATOR "i", a FluidBox is located at the WorkZone in the front. With a functional design, the sprayer operator will be able to quickly start the demanded operation. For non "i" version NAVIGATOR machines, a manual handle operation is offered.

- ▶ Easy operation of the SmartValves
- ▶ Control of filling, agitation, spraying and cleaning

Pressure	Suction
Tank cleaning	Suction from main tank
PressureEmpty/ TurboFiller	Suction from RinseTank
Filling	Suction from external source
Spraying	

# The liquid system

— Fast and reliable

The NAVIGATOR's fluid system (DynamicFluid4) employs advanced fluid dynamics and application rate control to deliver fast response and accurate target rate application.

Pressure, flow, pump speed, forward speed, boom sections and application rate are monitored and processed using advanced computations. The DynamicFluid4 processor analyses the spraying data 20 times a second and provides pre-emptive rate control capability, altering the pump speed with pinpoint precision.

The liquid system can be operated from the cabin or from the ground.

## The diaphragm pump

At the heart of the NAVIGATOR sits the robust and easy-to-service pump that HARDI is so well known for. The invention of this pump constituted the foundation upon which HARDI was founded more than 60 years ago. HARDI was the first to use diaphragms to separate the liquid from bearings, crankshaft and other vital pump parts, thereby allowing the pump to run dry without damage. In addition, this pump distinguished itself by being operated directly from the tractor's PTO shaft.



## Advanced filters

- ▶ EasyClean filter (Suction)
- ▶ CycloneFilter (Pressure)

## Suction filter

The EasyClean filter is a high-capacity suction filter. The filter's condition can be constantly monitored via a SafeSpray vacuum gauge to ensure it is cleaned only when necessary. When it's time for cleaning, simply twist the filter's lid 90° to close off its tank valve and open the filter for inspection. It doesn't get much easier than this.



## Pressure filter

The CycloneFilter is a unique self-cleaning pressure filter. A high-speed circular flow makes the cleaning very effective. A unique boost function allows the filter to be flushed when needed.



# i Intelligent features



## AutoFill – Fast and accurate filling

Set the volume, connect the hose – leave the rest to AutoFill, allowing the operator to carry out other tasks simultaneously.

- ▶ No overfilling – AutoFill stops at programmed volume
- ▶ Choose between maximum content or volume added
- ▶ Start/stop control at the FluidBox in the WorkZone
- ▶ Agitation is reduced automatically for maximum fill effect

## AutoAgitation – Agitation at its best

Fully automatic agitation for minimal filling time.

- ▶ Ensures even agitation as the tank empties
- ▶ Maximum agitation without foaming
- ▶ Minimal tank residues upon completion of spray job
- ▶ Automatic readouts of tank contents on terminal
- ▶ Manual override available through the FluidBox

## AutoWash – Easy, accurate and safe cleaning

Reduces residues to best in class – using only 400 litres of rinsing water.

- ▶ Operated from the tractor cabin
- ▶ No contamination of operator and tractor cabin
- ▶ No pesticide cross-contamination
- ▶ Choose one of three rinse programme – the rest is automatic
- ▶ In-field washing using multiple rinse operations
- ▶ Five rotating rinse nozzles in main tank for a thorough wash



# Instant spray control

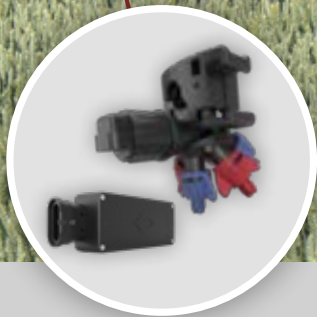

## PrimeFlow – Motorized nozzle on/off

PrimeFlow guarantees rapid priming and prevents sedimentation and clogging. When spraying is started, liquid has already been distributed in the entire boom, circulating at the requested pressure through the spray lines. When spraying is stopped, the liquid will continue to circulate at a standby pressure.

Even when spraying at low pressure, the spray lines are completely drained, leaving only a small residual volume, which means less liquid is required for cleaning.

- › Pressure circulation system – fast priming no residues
- › Electrically operated motor at each nozzle body
- › No untreated areas at spray start
- › No chemical sedimentation in the spray lines
- › Flushing of boom lines without spraying
- › Dynamic setup of sections from 1 to 12 nozzles
- › HARDI PENTALET holders for five nozzles

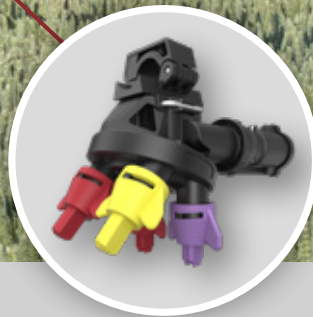

## AutoSelect Duo – Higher flexibility

Increase work rates with automatic nozzle change on the go in response to changing field and weather conditions – all operated from the cabin.

For example using a specific drift reduced nozzle on headland or in buffer zones. Increased working speed without compromises, when reducing speed at the headland a smaller nozzle can be used.

- › Pressure circulation system – fast priming no residues
- › Three combinations of two sets of nozzles
- › Applicable for speed variations of e.g. 8-15 km/h depending on nozzle type and pressure
- › Change application rate at constant speed and pressure
- › Maintain optimal droplet size
- › Particularly useful at the headland or other slowdown zones



## ActiveAir – Pneumatic opening of nozzles

ActiveAir is a pressure circulation system that open and close the nozzles instantly and without dripping. The rapid air activation is technically a combination of the PrimeFlow fluid system, the AutoSelect pneumatic actuators and solenoid valves to switch the air on/off.

The system requires an air tank on the sprayer and a compressor on the tractor, similar to the AutoSelect Duo system.

- › Pressure circulation system – fast priming no residues
- › Solenoid valves as section valve
- › 9 or 13 sections
- › Stainless steel nozzle tubes and PENTALET nozzle holder
- › Fast reaction – pneumatic opening of nozzles
- › Application map on section on/off

# AutoNozzleControl

*Maximum precision*



## Single nozzle control

Obtain full control of your spray job with our automated single nozzle on/off feature – AutoNozzleControl. In combination with the instant spray control offered by our PrimeFlow system, AutoNozzleControl gives you ultra precise spraying and faster driving speed with minimal overlapping.

AutoNozzleControl also allows you to switch off specific nozzles when turning on the headland and when spraying next to sensitive areas.

The system controls each nozzle automatically. In auto mode, the sprayer works with sections of 50 cm.

## AutoNozzleControl

- Save up to 10% chemicals
- Avoid crop damage
- Protect the environment

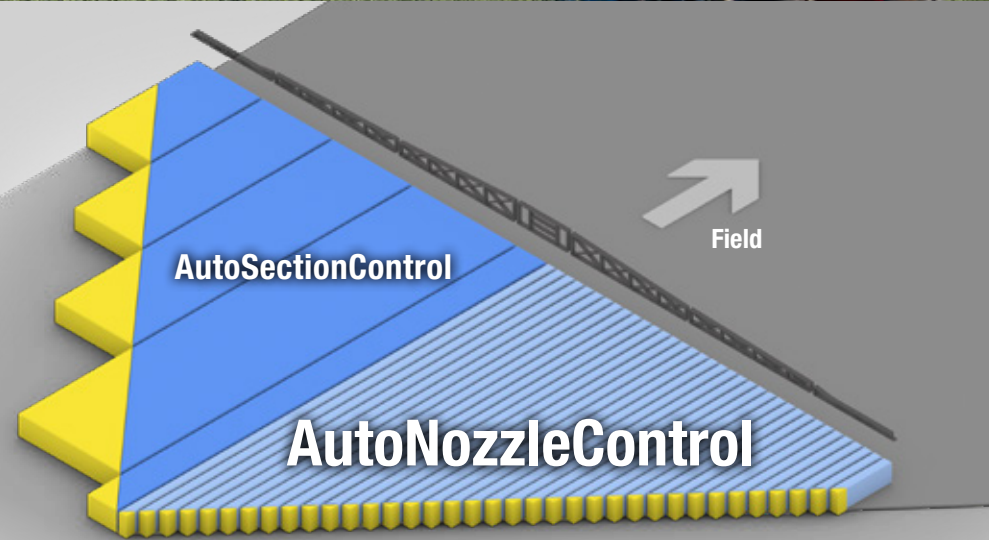

■ AutoNozzleControl   
 ■ AutoSectionControl   
 ■ Double sprayed area

# SmartCom

Prepared for the future

## The HARDI SmartCom – A future of plug-and-play with unlimited capacity

The intelligent HARDI SmartCom platform offers the user a full ISOBUS experience, meaning easy connection to tractors and controllers. The faster processor also offers you a more accurate and responsive liquid regulation system, as well as the ultimate steering system, thanks to faster response times.

We have prepared the HARDI SmartCom for online connections, so you will be able to connect to your favorite cloud solutions.

We have developed the new HARDI SmartLink cable to give the service staff the possibility of updating the sprayer, diagnosing errors and adding features, directly from the HARDI ServiceTool.

All in all, with the HARDI SmartCom, you are prepared for the future.



### SmartCom benefits

- ▶ Full ISOBUS for easy connection
- ▶ Quick and easy diagnostics with the HARDI ServiceTool
- ▶ Prepared for remote diagnostics
- ▶ Faster and more precise regulation system
- ▶ Ultimate steering precision
- ▶ Prepared for cloud connections
- ▶ Faster processing time



# HARDI ServiceTool

Prepared for cloud connections

## HARDI ServiceTool

The HARDI ServiceTool has two main functions. First it is used for updating the SmartCom ECUs, the second is to use it as a diagnostic tool in the field.



# Controllers

## Full ISOBUS control

### Complete integration

The complete integration of all important information on one work screen is a highly demanded criterion for most farmers. The HARDI touch-screen controller series are very easy to operate while providing an optimal overview for maximum control of the spray job.

All HARDI touch-screen terminals are ISOBUS terminals and made for spraying purpose. In combination with the Grip and the SetBox the operation in the field is easy and fast.

### Integrated electronics

From the working screen, the driver can operate AutoHeight, AutoSectionControl as well as guidance and dosing. The map screen view can 2D or 3D. The HC 9600, HC 8700 and HC 9700 screens are able to divide the information with split screen for a better overview.

### Data management and data transfer

The USB ports and the WiFi adapter allows data to be exchanged. This simplifies application reporting, providing

an easy way to generate detailed application reports for governmental record keeping. The data can be transferred to different farm management software.

### ISOBUS terminal

The SmartCom system is always ISOBUS. The customer can order the NAVIGATOR and use the intelligent functions like AutoSectionControl direct from his own ISOBUS terminal if supported. To make the complex sprayer operation easier, the proven HARDI Grip and Setbox are standard equipment.

### Extend your work screen

Use your mobile device or tablet to perform calibration, diagnostics, tank fill and many other activities anywhere around your machine. Using the XTEND technology, you can extend the user interface of your HC 8700 and HC 9700 to the screen of a iOS or Android device using a WiFi connection.

Feature	HC 9700	HC 8700	HC 9600	HC 8600
Mode of action	12.1" (30.7 cm)	8.4" (21.3 cm)	12.1" (30.7 cm)	8.4" (21.3 cm)
ISOBUS Universal Terminal	●	●	●	●
Mini view screens	3	2	UT Split screen	N/A
Dashboard & Interaction Keypad	●	●	N/A	N/A
HARDI workscreen	N/A	N/A	●	●
USB ports	●	●	●	●
WiFi adapter			●	●
Horizon XTEND	Optional	Optional	●	●
AutoSectionControl	●	●	●	●
Lightbar Guidance	On screen	On screen	In housing	In housing
Coverage Mapping	●	●	●	N/A
Data Logging	●	●	●	●
Variable Rate Application	●	Optional	●	●
Application Report	●	●	●	N/A
Boom Height Control	UT	UT	Integrated	Integrated
Camera Support	●	●	● Out	● Out
ISOXML data transfer	● In/Out	● In/Out	● Out	● Out



HC 8600

HC 9600



HC 8700

HC 9700



SetBox and Grip

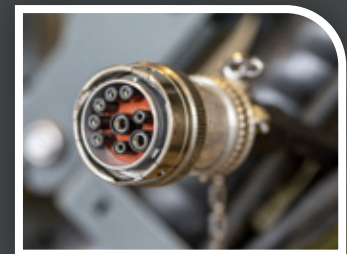

ISOBUS

# Field mapping

– Minimise chemical usage and costs

## Higher precision in your spray job

Precision is key to spraying. The HC 9700 controller offers the possibility to use ISOXML field maps in conjunction with your preferred farm management software. Task Data mode allows you to select, configure and run a task from the imported task data. Drawing on the features of the AutoSectionControl system, the HC 9700 allows you to shut off boom sections automatically in accordance with your field maps. Avoiding over-spraying reduces expenses and makes your farm more environmentally friendly. Field maps also makes it easier to work in conditions of low visibility such as dust or darkness.

## Field mapping benefits

- ▶ High application precision
- ▶ Less usage of chemicals
- ▶ No overlapping areas



# The DELTA FORCE boom

– High performance



### Compact on the road – wide in the field

The DELTA FORCE boom is made to perform. It is a practical but strong boom designed for productivity and performance. We have optimised weight and strength to produce a large boom for reliable performance at fast spray speeds. Despite its width, the DELTA FORCE boom is only 2.55 m wide when folded up for

transport. The boom's simple yet effective pendulum suspension controls boom movements, while a low centre of gravity ensures perfect boom balance. With just two parameters to adjust (pendulum and dampening), the DELTA FORCE boom is easy to customise and maintain.

### Material optimisation

We always seek to use the most innovative combinations of materials. The DELTA FORCE boom is a prime example. The 39 m boom consists of a high-strength steel centre with lightweight aluminium outers and break-away.

- ▶ Superb boom stability with AutoTerrain and NegativeTilt
- ▶ Precise application with hydraulic AntiYaw dampening
- ▶ Higher durability and lower weight
- ▶ Manual control at power outage
- ▶ Easy handling with hydraulic support wheels and AutoTerrain sensors



21-39 m



AutoTerrain



AutoSlant

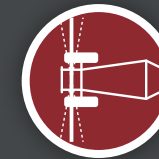

AntiYaw



NegativeTilt

**HARDI DELTA FORCE**  
is available in:

- 3-fold:**  
39/27/15 m,  
36/27/15 m,  
36/24/13 m,  
33/25/15 m,  
33/24/13 m,  
32/25/15 m,  
30/24/13 m,  
30/21/12 m,  
28/21/12 m,  
27/21/12 m.
- 2-fold:**  
30/15 m,  
28/14 m,  
27/14 m,  
24/12 m,  
21/12 m

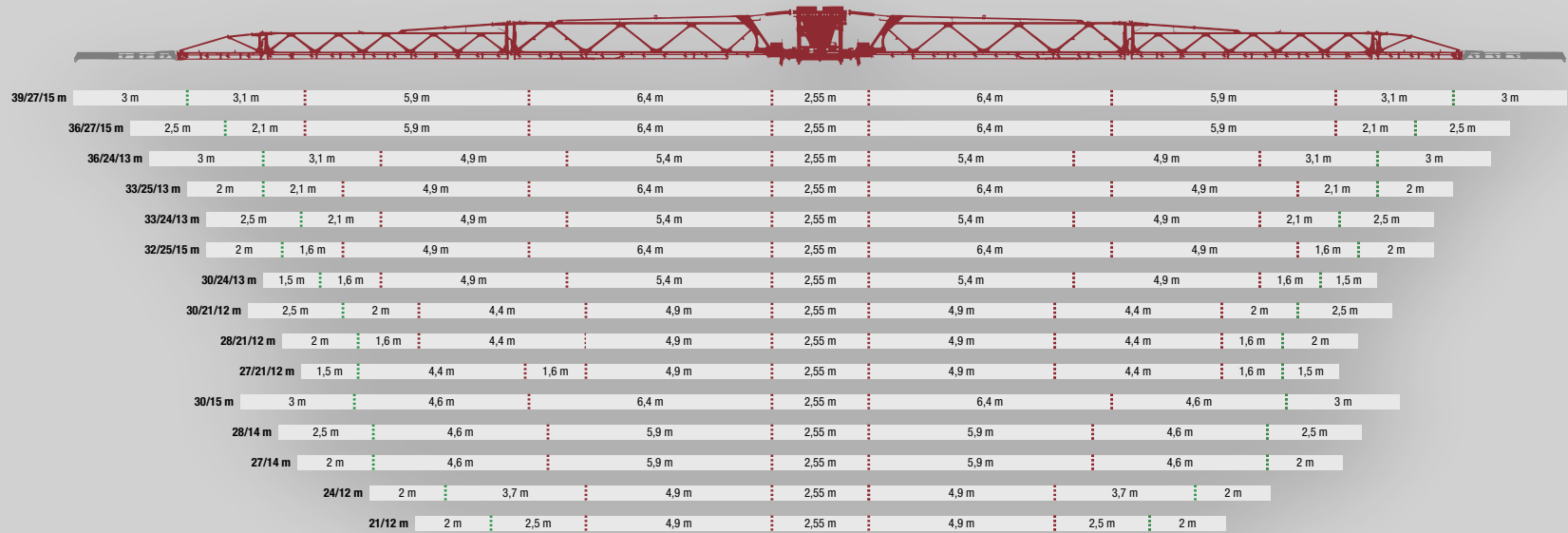

**One boom – two spray widths**

HARDI's boom-folding system allows the operator to spray at two different widths by choosing whether to fold out the last section.

**Minimize boom movement**

For a perfect application result, reduction of the horizontal movements is crucial.

The DELTA FORCE boom is as standard equipped with an AntiYaw dampening system between the center section and the boom wings. The 24 to 30 m booms have a rubber dampening system as standard and hydraulic dampening as option, while the 32 to 39 m are equipped with an hydraulic dampener as standard.

**Less drift**

The DELTA FORCE boom can be fitted with additional nozzle holders to allow for a 25 cm spacing between nozzles in addition to the standard 50 cm.

In combination with the AutoTerrain boom management system, this reduces potential drift by allowing for a lower boom height. It also means that smaller nozzles with smaller droplets can be used to improve crop coverage.

# Boom management systems



## Fast and precise applications

Our boom management systems are all designed to ensure superb boom stability. A stable boom is key to spray precision and productivity, especially when working with low boom heights at high speeds

Automatic control of height, slant, tilt and yaw optimises the boom position, and all but eliminates the risk of hitting the ground. It also reduces the risk of drift to the benefit of farmer and environment. Yaw is counteracted by hydraulic accumulators, which power up every time the boom unfolds. Each side can be automatically levelled independently, giving you the possibility of negative tilt.

The result is exceptional application precision, even at fast driving speeds.

A stable boom reduces wear and tear on both the sprayer and its operator. The sprayer will have a longer lifespan, and the operator will experience less fatigue and stress, because the automatic systems reduce the need for constantly monitoring the boom.

## AutoTerrain

This unrivalled boom management system distinguishes itself from others by preventing rather than correcting unintended boom movements. Using ultrasonic sensors on the boom wings and

angle sensors at the centre, it monitors the boom's movements continuously, responding to forces acting upon the boom before it is disturbed. By making smooth adjustments to the boom's slant, tilt and height, AutoTerrain provides accurate contour following and crop clearance – essential for precise spray application.

The AutoTerrain system has been tested under rigorous field conditions, showing excellent performance when spraying with low boom heights at high driving speeds of more than 15 km/h.

When turning on headlands, the AutoTerrain system will counter the boom's natural pendulum effect to prevent the inner side from dipping. The result is a level boom throughout the turn.



## AutoSlant

AutoSlant controls boom height and slant.

- ▶ Boom height
- ▶ Hydraulic slant
- ▶ 2 ultrasonic sensors
- ▶ Available for:

**VPZ and DELTA FORCE**



## AutoTerrain:

- ▶ Boom height
- ▶ Hydraulic slant
- ▶ Individual tilt of boom wings
- ▶ Negative tilt
- ▶ 3 or 5 ultrasonic sensors
- ▶ 3 angle sensors on the center
- ▶ 3 temperature controlled proportional valves
- ▶ Available for: **DELTA FORCE**



## NegativeTilt

Negative tilt for superb boom stability, allows for downward tilting of the boom by up to -4°, especially useful when spraying a lower level, for instance on a ridge.

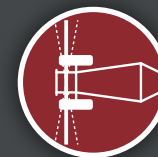

## AntiYaw

Dampens horizontal movements and shock loads in the boom.



# The VPZ Boom

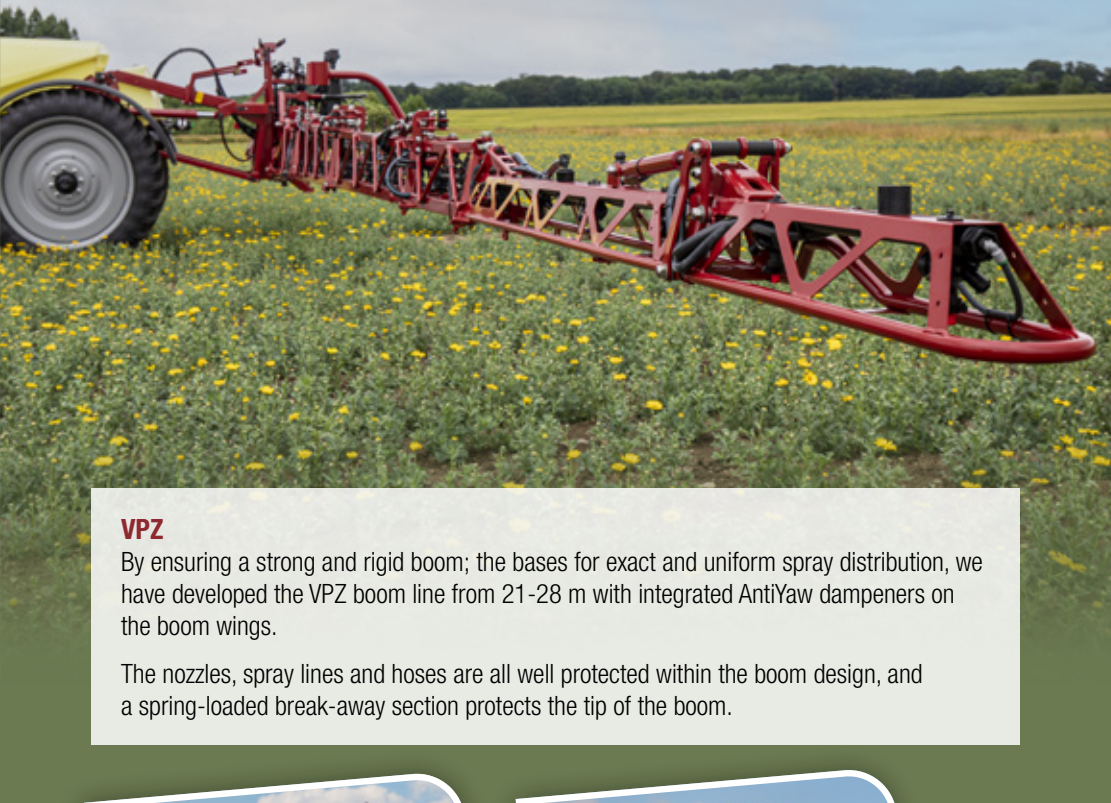

## VPZ

By ensuring a strong and rigid boom; the bases for exact and uniform spray distribution, we have developed the VPZ boom line from 21-28 m with integrated AntiYaw dampeners on the boom wings.

The nozzles, spray lines and hoses are all well protected within the boom design, and a spring-loaded break-away section protects the tip of the boom.



# The EAGLE boom



## EAGLE

The 18-30 m EAGLE boom is designed for heavy-duty use under the most demanding conditions and minimum service. The boom is well-known around the world for its performance under the hardest conditions.

The EAGLE boom is suspended on two large coil springs with shock absorbers. The horizontal movements are controlled by a heavy-duty trapeze system that allows spraying and turning at very high working speeds.

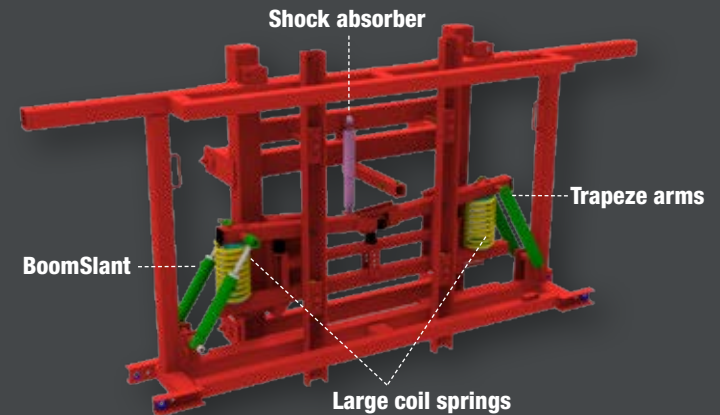

# Optional extras



*In-Line filter*



*ChemLocker*



*BoomFlush*



*External cleaning kit*

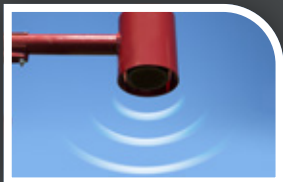

*HARDI AutoSlant/AutoTerrain*



*Hoses for liquid fertilizer*



*BoomPrime*

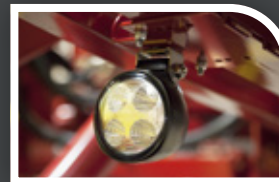

*Night spraying light*

# Technical specifications

Tank, litres	3000	4000	5000	6000
Pumps, type – l/min	464-280 / 464H-334			
Booms, m	DELTA FORCE 21-28 m (2-folded) DELTA FORCE 27-36 m (3-folded) EAGLE 18-30 m VPZ 20-28 m	DELTA FORCE 21-28 m (2-folded) DELTA FORCE 27-36 m (3-folded) EAGLE 18-30 m VPZ 20-28 m	DELTA FORCE 24-39 m EAGLE 24-30 m	DELTA FORCE 24-39 m EAGLE 24-30 m
RinseTank	500	500	500	500
Total height, m (A)	3.80 (340/85R48)	3.80 (340/85R48)	3.80 (520/85R42)	3.80 (520/85R42)
Total length, m (B)	7.2	7.2	8.00	8.00
Length draw to axel, m (C)	5.30	5.30	6.05	6.05
Turning radius IntelliTrack, m	6.00	6.0	8.5	8.5
Track width, m (D)	1.50-2.25	1.50-2.25	1.80-2.25	1.80-2.25
Width DELTA FORCE, m (E)	-	2.55	2.55	2.55
Width EAGLE, m (E)	3.00	3.00	3.00	3.00
Width VPZ, m (E)	2.30	2.30		
Clearance, m (F)	0.8 (340/85R48)	0.8 (340/85R48)	0.81 (520/85R42)	0.81 (520/85R42)
Weight total (empty tank), kg	3300-4600	3400-4700	4950-5850	5000-5900
Suspension	Optional	Optional	Optional	Optional

## DELTA FORCE 21-39 m

DELTA FORCE is designed to be a large boom. The selection of features and the layout of the boom structure is targeted to perform at high driving speed and high performance at boom widths of 21-39 m.

## EAGLE 18-30 m

The EAGLE boom offers unequalled performance in rough conditions. The strong and well-proven two-dimensional EAGLE boom is the ideal choice for operators looking for durability and value.

## VPZ 21-28 m

By ensuring a strong and rigid boom; the bases for exact and uniform spray distribution, we have developed the VPZ boom line from 21-28 m with integrated AntiYaw dampeners on the boom wings.

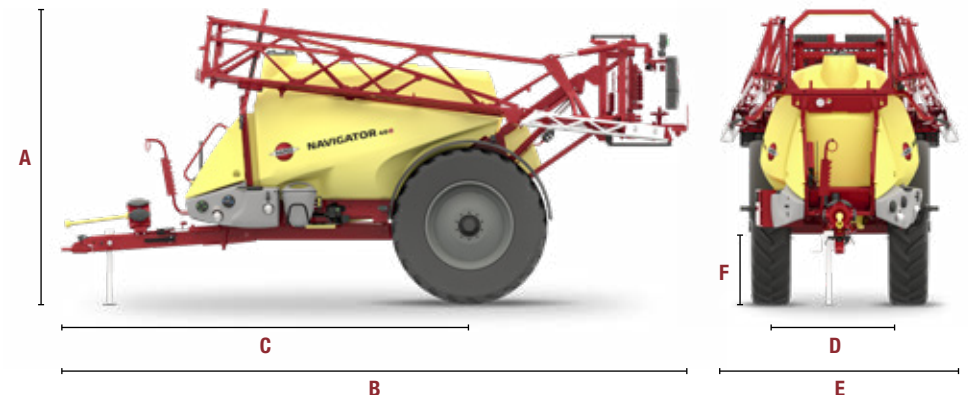

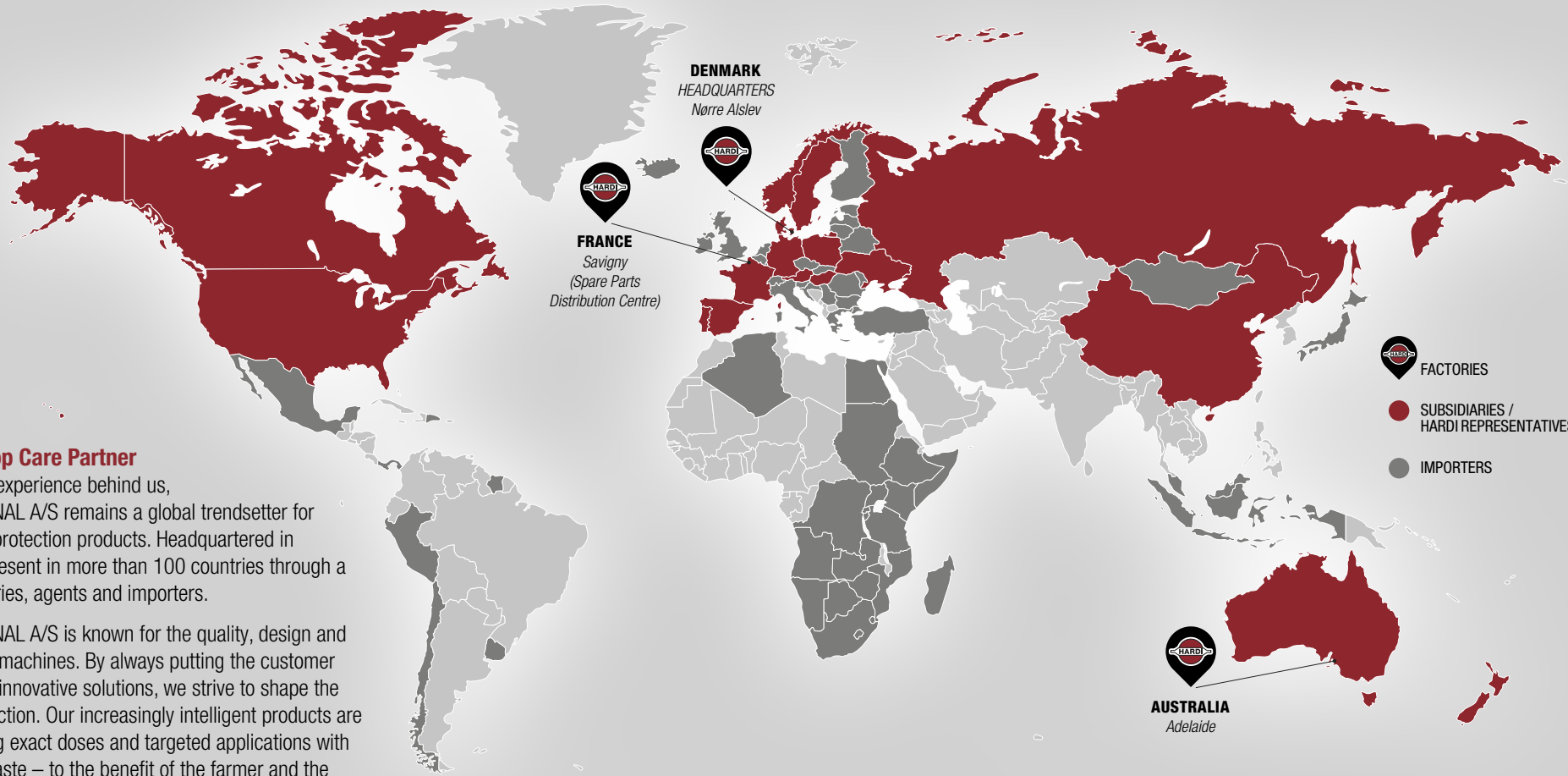

-  FACTORIES
-  SUBSIDIARIES / HARDI REPRESENTATIVES
-  IMPORTERS

**HARDI – Your Crop Care Partner**

With over 60 years experience behind us, HARDI INTERNATIONAL A/S remains a global trendsetter for application of crop protection products. Headquartered in Denmark, we are present in more than 100 countries through a network of subsidiaries, agents and importers.

HARDI INTERNATIONAL A/S is known for the quality, design and performance of our machines. By always putting the customer at the centre of our innovative solutions, we strive to shape the future in plant protection. Our increasingly intelligent products are capable of delivering exact doses and targeted applications with minimal drift and waste – to the benefit of the farmer and the environment.

We believe in a future where our products will be able to take care of plants one by one.

The HARDI Group is a division in the Agricultural Spraying segment of Exel Industries S.A.



Your Crop Care Partner

**HARDI INTERNATIONAL A/S**

Herthadalvej 10 · 4840 Nørre Alslev · Denmark · Tel: +45 54 46 48 00  
 Email: info@hardi.com · www.hardi.com



#HARDIsprayers