

6R Series Tractors

Go smarter



JOHN DEERE







Contents

Streamlined farming	4
Go smart, do more	6
Overview	8
Small frame tractors	10
Mid frame tractors	12
Large frame tractors	14
Xtra large frame tractors	16

Precision ag technology

Work Planner	18
CommandCenter™	20
The precision farming advantage	22
Land management	24
Documentation made easy	25

Cab

CommandPRO™ joystick	26
Operators comfort	28
CommandARM™	30

Engine

Power without limits	32
----------------------------	----

Transmissions

AutoQuad™ Plus	34
CommandQuad™ Plus	34
DirectDrive	35
AutoPowr™	36

Lighting

Light up the night	38
--------------------------	----

Comfort and stability

Great ride, all the power	40
---------------------------------	----

Hitches

Get hitched to productivity	42
-----------------------------------	----

Hydraulics

Smarter hydraulics	44
--------------------------	----

Loaders

Maximise your day	46
-------------------------	----

Specifications

Specifications	48
----------------------	----

Streamlined farming

The new 6R family is the number one in intelligent automation and transport—your high-power, low-weight performance solution with supreme pulling power.





Maximum Durability

The John Deere full frame design forms the rugged backbone of all 6R Series tractors. Engine and transmission are mounted within the frame on insulating blocks that reduce stress and operating noise. It's the perfect platform for a John Deere front loader.

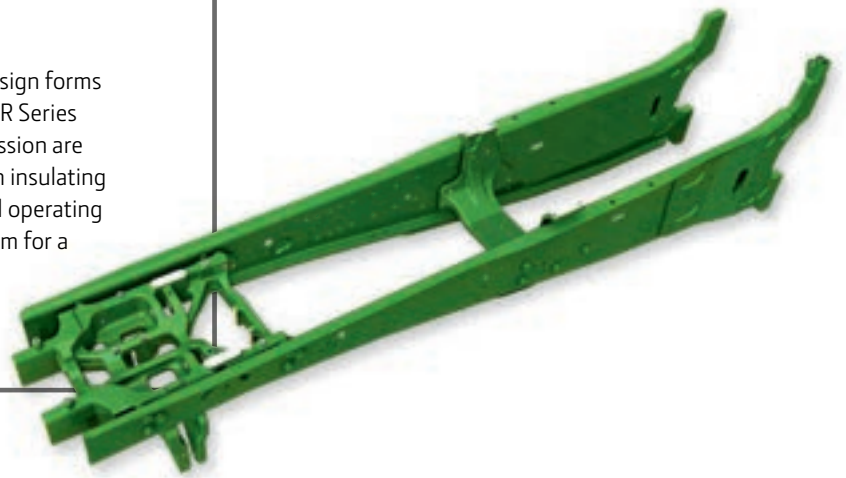

Go smart, do more

Every 6R tractor is designed and engineered to be a versatile, light and powerful constituent of your workforce, built to overcome the diverse challenges presented by terrain, prevailing conditions and operational windows.

New and even smarter

When you improve the best, great things happen. Building on its legendary pulling power, reliability and comfort, we gave the 6R Series some new and even smarter models.



1. Work Planner

Reduce in-field setup time by up to 50%: Tasks planned in the Operations Center automatically appear on the Gen4 display when entering the field—just one click confirms the details to start working.

2. First in transport

Our 6R 250 is unbeaten in the DLG PowerMix Transport 2.0 Test, and the Chamber of Agriculture Lower Saxony (Germany) confirmed the exceptional efficiency of the 6R 215 in their 2020 tractor test*.

3. Always up-to-date

JDLink™ enables remote servicing and operator support, and our regular over-the-air software upgrades ensure your tractor always has the latest updates.

7. Smarter hydraulics

Smarter Intelligent Power Management for up to 30 additional kW (40 hp) in hydraulic applications and up to six rear selective control valves (SCV's) with up to 160 L/min hydraulic flow for top productivity.

8. Outstanding cab

Extra spacious 3.33 m³ very quiet 71 dB(A) cab combined with new Corner Post Display, manufactured to automotive industry standards.

9. CommandPRO™

Perfect ergonomics, driving strategy and reconfigurability.

* Chamber of Agriculture Lower Saxony (Germany) tractor test



Does it all

Whether you're a livestock farmer, arable farmer, mixed farmer or a contracting business—one of our 6Rs was made for you.

4. Low cost of ownership

Low fuel consumption, low maintenance and repair costs and a very strong resale value guarantee great value for money.

5. Engine performance

The 4.5 L or 6.8 L John Deere engines with up to 300 hp maximum power give you fantastic power at reduced operating costs.

6. Transmissions

Extra convenient AutoQuad™ Plus and CommandQuad™ Plus, super efficient and powerful DirectDrive and efficient stepless AutoPowr™.

10. Comfort

TLS™ Plus front axle Suspension and HCS Plus cab suspension work together to provide the best ride and drive experience.

11. Axles and tyres

Large rear tyres for maximum pull. TLS Plus and Variable Ratio Steering in the front axle for outstanding comfort.



Small frame

Compact, light and powerful

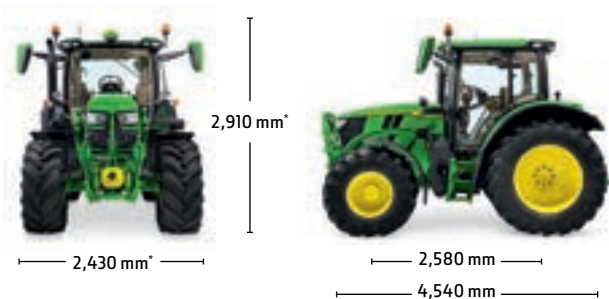

* With 540/65R24 front tyres and 600/65R38 rear tyres

6,100 kg**

Engine performance

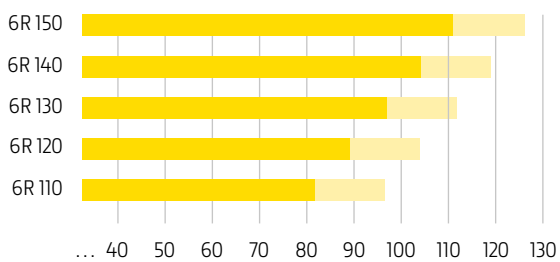

■ Rated power (ECE-R120), kW
 ■ Rated power with IPM (ECE-R120) at 2,100 rpm, kW (hp)

**Base spec machine weight



Mid frame

Ultimate versatility and performance

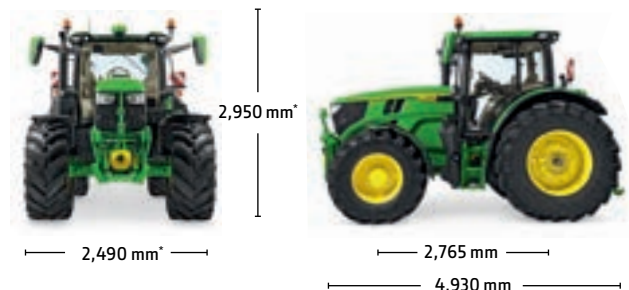

* With 540/65R28 front tyres and 600/65R38 rear tyres

7,000 kg**

Engine performance

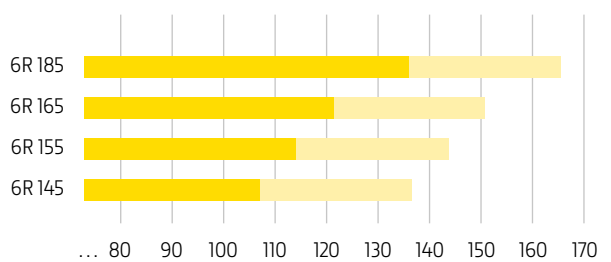

■ Rated power (ECE-R120), kW
 ■ Rated power with IPM (ECE-R120) at 2,100 rpm, kW (hp)



Large frame

The power to perform



* With 600/70R30 front tyres and 800/70R38 rear tyres

8,400 kg**

Engine performance

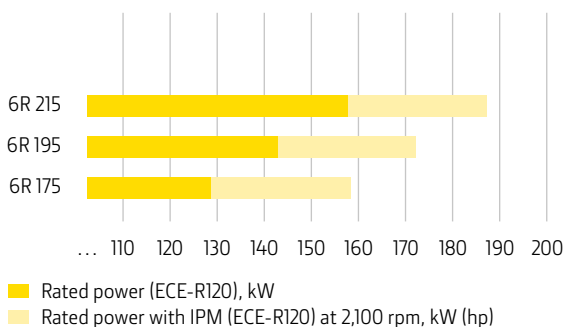

Extra-large frame

Powerfully tough



* With 600/70R30 front tyres and 800/70R38 rear tyres

9,300 kg**

Engine performance

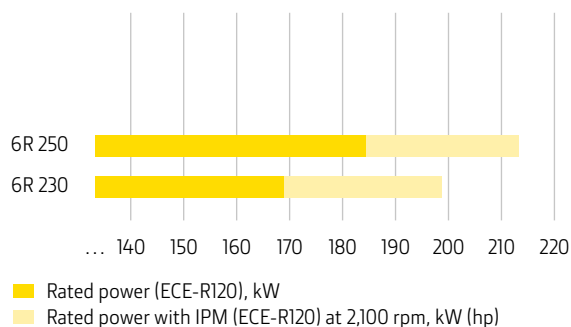

6R small frame tractors

Compact, light and powerful

Experience the versatility of this manoeuvrable, high-horsepower 4-cylinder tractor with its strong hydraulics, high lift capacity and large tires.

Engines

	6R 110	6R 120	6R 130	6R 140	6R 150
Cylinders	4	4	4	4	4
Displacement (L)	4.5	4.5	4.5	4.5	4.5
Rated power (ECE-R120), kW (hp) "Power in field"	81 (110)	88 (120)	96 (130)	103 (140)	110 (150)
Rated power with IPM (ECE-R120), kW (hp) "Power in transport & PTO"	96 (130)	103 (140)	110 (150)	118 (160)	125 (170)



Top all-rounder

With a higher lift capacity, 4 tonnes of payload, and larger tyres for less compaction, this 6R is ready for any job.

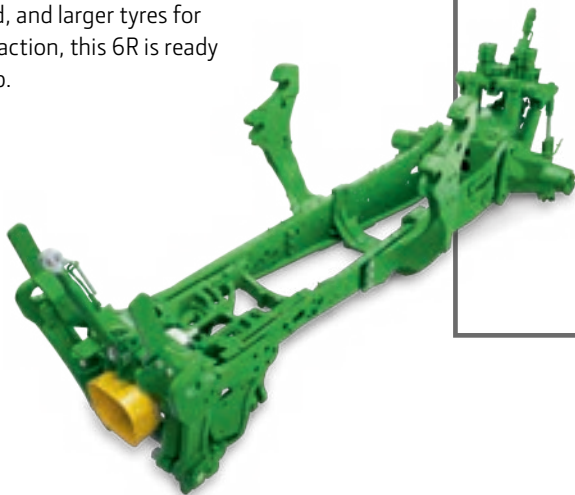

Front loading expert

The rugged John Deere full frame design, their high-maneuvrability short wheelbase, and up to 155 L/min hydraulics (Optional for 6R 130, 6R 140 and 6R 150) predestine the 6R Small Frame models for loader work. Reach new levels of productivity with the R Series loaders, featuring a dynamic weighing system, return-to-position and level-to-horizon.



Ease of use

Enjoy less clutching and experience less tiresome, more productive days in the cab with the enhanced automatic capabilities of CommandQuad™ Plus*.



* not available for the 6R 150



6R mid frame tractors

Ultimate versatility and performance

In our 6R 185, you will command up to 174 kW (234 hp) maximum power with IPM in a lightweight, 7.9 tonnes mid-frame envelope with unmatched acceleration and exceptional versatility.

Engines

	6R 145	6R 155	6R 165	6R 185
Cylinders	6	6	6	6
Displacement (L)	6.8	6.8	6.8	6.8
Rated power (ECE-R120), kW (hp) "Power in field"	107 (145)	114 (155)	121 (165)	136 (185)
Rated power with IPM (ECE-R120), kW (hp) "Power in transport & PTO"	136 (185)	143 (195)	151 (205)	165 (225)

Transport masters

The 6R 165 and 6R 185 are new light-weight, high-horsepower 6-cylinder models that extend our mid-frame lineup with two new transport specialists.



Top hydraulics

An impressive flow of up to 155 L/min and hydraulic IPM with up to 30 additional kW (40 hp) keep tractor performance consistent in applications with power-hungry hydraulic driven implements.



Great choices

Experience the superior ease of operation of our top-of-the-line AutoPowr™ transmission, or opt for the heavy-duty dual-clutch eight-speed, three-range DirectDrive transmission* specifically developed for 6R tractors.



DirectDrive



AutoPowr

* not available for 6R185

6R large frame tractors

The power to perform



Officially efficient: Contractors prefer these tractors for their outstanding efficiency*, top on-road performance, and the rock-solid, comfortable ride in all heavy-duty applications.

Engines

	6R 175	6R 195	6R 215
Cylinders	6	6	6
Displacement (L)	6.8	6.8	6.8
Rated power (ECE-R120), kW (hp) "Power in field"	129 (175)	143 (195)	158 (215)
Rated power with IPM (ECE-R120), kW (hp) "Power in transport & PTO"	158 (215)	173 (235)	188 (255)

* As recently confirmed for the 6215R in the Schleppertest 2020 by the Chamber of Agriculture Lower Saxony (Germany)

Officially number one

At only 19.2 L/h, the 6R 215 achieved the lowest diesel consumption in the test* and delivered the quickest acceleration pulling 30 tonne trailers*—outperforming competitors in the 250 hp test.



Electronic control

The electronic joystick enables you to reconfigure hitch control, all SCV's, ISOBUS functions and the PowerReverser™ for convenient and efficient one-handed control of essential tractor functions.

Transmission choices

We developed our advanced dual-clutch technology specifically for 6R tractors and the heavy-duty agricultural challenges you put them through. If you are also looking for superior ease of operation, opt for our top-of-the-line AutoPowr™ transmission.



DirectDrive



AutoPowr

* Chamber of Agriculture Lower Saxony (Germany) tractor test



6R xtra large frame tractors

Powerfully tough

More power all around, and a 100 mm longer wheelbase at 2.05 m to get the tremendous power of these models to the ground with total efficiency.

Engines

	6R 230	6R 250
Cylinders	6	6
Displacement (L)	6.8	6.8
Rated power (ECE-R120), kW (hp) "Power in field"	169 (230)	184 (250)
Rated power with IPM (ECE-R120), kW (hp) "Power in transport & PTO"	199 (270)	213 (290)

True power

With a 160 L/min hydraulic pump and PTO options like the 540E/1000/1000E, 6R xtra large frame models give you the powerful versatility to meet all implement demands.



Number one, again

Since 2018, the John Deere 6R 250 has been unbeaten in the DLG PowerMix Transport 2.0 Test, where the 6R 250 delivered the lowest fuel consumption compared to all competitors tested.

AutoPowr™—IVT™

The superior ease of operation of our top-of-the-line AutoPowr transmission complements the power and torque of your 6R—experience outstanding fuel efficiency and exceptionally high levels of operating comfort.



Work Planner

Cut set-up time by up to 50%

Are you fed up with scribbling notes and wasting time clicking on displays? With Work Planner, you can reduce in-field setup time by up to 50%: your preplanned work tasks in the Operations Center automatically appear on the Gen4 Display when a machine with JDLink™ connectivity enters the field. All the operator has to do is confirm the details with one click, and they're ready to go*.

Wirelessly send tasks to the tractor via JDLink Connectivity to make sure the work gets done the way you want—no mistakes, no delays, and always properly documented.



* Machine must be equipped with a Generation 4 CommandCenter™ or Universal Display (with minimum SU20-3 Software), StarFire™ 3000/6000 receiver, JDLink Connectivity and a John Deere Operations Center account. If not already equipped with compatible telematics hardware a retrofit is required.



WORK PLANNER

Sign up for a free account at operationscenter.deere.com

Preplanned work tasks automatically appear on the Gen4 Display. That saves you 90% of clicks.

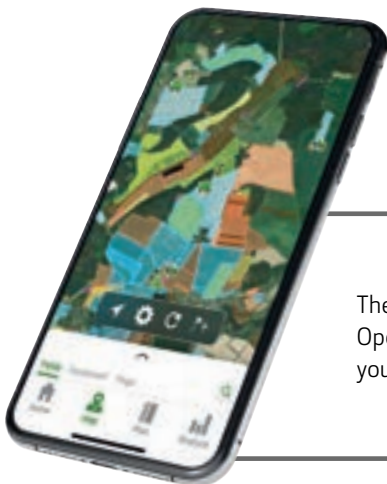

The Work Planner tool in the Operations Center will cut your set-up time by up to 50%.





Next level automation

CommandCenter™ Automation

On top of all the Premium Activation features, you'll also enjoy the added productivity benefits of AutoTrac™ Turn Automation, AutoTrac Implement Guidance (Passive), AutoPath™ and Machine Sync.

Autotrac turn automation

AutoTrac Turn Automation controls the entire headland turn and manages all tractor and implement functions, including forward speed changes and PTO switching. It raises or lowers the hitch or activates SCVs at exactly the right time and position in the field to guarantee perfectly consistent headland crop growth.

AutoTrac implement guidance

AutoTrac Implement Guidance helps maximize the use of inputs by increasing accuracy and repeatability at the implement thanks to a second receiver on the implement. Having a second StarFire™ receiver located on the implement allows the tractor to guide the implement through the field with additional accuracy, even on curved passes and sloping terrain.



AutoPath

AutoPath automatically creates guidance lines for different width machines based on data gathered by the first pass of a strip till implement or planter. It takes charge of your guidance line management, protecting nutrient investment and helping you make each pass with confidence and precision. If you are using different width implements for planting, spraying or harvesting AutoPath ensures the tyres will always follow the planted rows and stay off the crop. When harvesting, the combine will always be guided to the correct starting point and the guidance lines will be automatically calculated based on the width of the header.

Machine Sync

Machine Sync is a powerful machine-to-machine automation application that synchronises both the speed and steering between a leader vehicle and a follower in the field. For instance, a combine and a tractor with grain cart. This eliminates the risk of collision during unloading on the go and ensures even, spill-free filling. Machine Sync also provides information on grain tank fill levels and combine position for more efficient harvest logistics planning and management.



The precision farming advantage

CommandCenter™ Premium

The CommandCenter Premium Activation is your ticket to the benefits of site-specific farming.



Section Control

Section Control (TC-SC) minimises skips and overlaps automatically on-the-go. Controlling up to 255 individual sections it saves you significant money on fertiliser, chemicals and seed.

In-field data sharing

In-field data sharing lets you see coverage and as-applied maps for machines working in the same field at the same time. It's how you can make sure that you get complete field coverage with multiple machines, even in low light and/or dusty conditions, while you reduce over-application, obtain more accurate documentation data and lower input costs.

AutoTrac™ vision

The perfect steering solution to reduce crop damage in fields planted without a guidance system. A combination of a front mounted camera and auto-generated A-B lines guides the tractor for faster working speeds up to 30 km/h and will help you cover up to 20% more hectares in a day.

Manage your fields the smart way

The John Deere Operations Center brings together all your farm management data together in one place. Easy-to-understand, its integrated tools support your agronomic decision making and help you get maximum yield and consistent quality from your soil at significantly reduced input costs. What's more, an Operations Center account is free to use no matter how big your operation is.

Plan your crop rotation and tasks for the upcoming season with a structured overview that will make it effortless to create display set-up files and work orders. As the individual task are being completed, your documentation data is automatically uploaded from your in-cab display to your personal Operations Center account. From there all operational details are easily visualised on a nicely structured timeline. You can access it anytime, anywhere, from any internet-capable device, allowing you to view your mapping or compare different map layers like yield, dry matter, crop constituents, and application rates.

The Operations Center is how you turn valuable agronomic insights into smart decisions and easily define corrective actions. Other integrated tools let you create site-specific variable rate prescriptions and allow you to collaborate with agronomic advisors by granting them field-specific access rights. Documenting your work for clients also becomes a breeze with easily created, printed and shared reports.



Operations Center Mobile

A powerful app is available for tablet and smartphone.



Manage your land in Operations Center

Using the John Deere Operations Center you can carefully plan your work during off-season. Easily create, edit or delete display set-up data like clients, farms and fields, boundaries, guidance lines and much more. All you need to wirelessly exchange data between your tractor and the Operations Center is already installed in your tractor with JDLink™.



Together, JDLink and the John Deere Operations Center connect your office and your machines to improve overall business efficiency.

New field boundaries can be easily imported from a third party or farm management software via shapefile. You can also draw them online or modify any existing boundaries, which is a great help for first time field localisation, especially if you contract or use seasonal employees. When you're done you can wirelessly send all data to the machines you select at the push of a button—eliminating time-consuming and error-prone manual set-up on multiple displays in the field. When you approach a new field, the related client, farm and field data will automatically be detected. Upon confirmation, the boundaries are loaded, and the preferred guidance line can be chosen from a pre-populated list. Finally, your display data is always backed up to the Operations Center.

Your benefit

- Quick and easy in-field display set-up
- Automated, reliable and error-free documentation
- Automated data back-up



Documentation made easy

Cross compliance reporting the smart way

The John Deere Operations Center puts your farm in your pocket: Easy-to-understand, integrated tools support your agronomic decision making and help you get maximum yield and consistent quality from your soil at significantly reduced input costs.

Plan your crop rotation and tasks for the upcoming season with a structured overview that will make it effortless to create display set-up files and work orders. As the individual tasks are being completed, your documentation data is automatically uploaded from your in-cab display to your personal Operations Center account. From there all operational details are easily visualised on a nicely structured timeline—anytime, anywhere, from any internet-capable device, allowing you to view your mapping or compare different map layers like yield, dry matter, crop constituents, and application rates.

This is how you turn valuable agronomic insights into smart decisions and more easily define corrective actions. Other integrated tools enable you to easily turn this data into site-specific variable rate prescriptions and allow you to collaborate with agronomic advisors by granting them field-specific access rights. Finally, documenting your work for clients becomes a breeze with easily created, printed and shared reports.

Your benefit

- All info in one centralised location, nicely structured and easily accessible
- Gain insights for smart, fact-based decisions
- Leverage numerous additional agronomic tools for further data processing and analysis
- Easy and fast data transfer with JDLink connectivity

CommandPRO™ joystick

Mastering the power of the 6R Series tractors is simple with the CommandPRO joystick and its 11 reconfigurable buttons. It's the ultimate driver interface for making every work day even more comfortable and productive.

The ultimate driver interface

- Set top and zero speeds with one simple push or pull
- Creeping control from 0 to 2 km/h
- Simultaneously active pedal and joystick driving
- ActiveZero function keeps the output speed actively at 0 km/h until the acceleration command is given
- Control ISOBUS implements with CommandPRO*



Settings manager

Reducing the set-up time for all your applications, the Settings Manager allows you to save machine settings such as engine, SCVs and rear hitch, as well as configuration settings for the electronic and CommandPRO joysticks. Instantly access the individual settings for implements or operators and be productive from the moment you take the wheel.

* only available with AUX-N AEF certified ISOBUS implements



1

Travel set speed buttons 1 and 2

2

Acceleration response button with three settings

3

Travel speed adjustment wheel

4

Activation button

5

11 Reconfigurable buttons for:

- Front/Rear Hitch
- Front/Rear PTO
- SCV's
- iTEC™
- AutoTrac™
- ISOBUS functions
- Engine set speed



Do your best work ever

You'll sit down, you will look around, and you will know it: I'm going to get things done here. Better, faster, more efficiently. At a quiet 71 dB(A), you'll enjoy our roomy 3.33 m³ cab every time you get in.



With Leather Package*

1. Doors you don't see

Our panorama doors don't look like much. That's a good thing. You'll enjoy the unobstructed view through them. A left-hand side B-post version is also available.

3. Bluetooth™ radio

Provides Bluetooth telephone connectivity with hands-free functionality.

2. Storage to unclutter your cab

Our storage box gives you convenient access to items you want to bring along. Instead of it, we also have a small fridge available that fits the space.

4. Sit better

Premier seats for less fatigue, more productivity. Options include a swivelling air suspended seat and the Ultimate Seat with Active Climate System.

* Includes leather seat, leather instructor seat, leather wrapped steering wheel, carpet floor mat and rear window decal

Intuitive control

CommandARM™

The 6R Series makes sophisticated agricultural technology easy to operate. Everything is within easy reach, and our touchscreen CommandCenter™ features fluid navigation with shortcuts and context-sensitive help.

4200 Display

With a 21.3 cm (8.4") touchscreen and one video input, our standard display is one of the most advanced in the industry. It comes with full AEF ISOBUS certification, Remote Display Access, wireless data transfer connectivity to the John Deere Operations Center, and supports AutoTrac™ and Gen 4 CommandCenter Premium.

4600 Display

The optional 4600 CommandCenter features a 26.4 cm (10.4") touchscreen, four video inputs and the option to connect to the Extended Monitor. It supports AutoTrac, Gen 4 CommandCenter Premium and Gen 4 CommandCenter Automation to enable the full range of advanced precision agriculture applications.

Easy menu navigation

Navigation is easy with a logical menu structure and a comprehensive shortcut bar. With Quick Line you can now record an AB line with just one button press.



Extended Monitor

The Gen4 Extended Monitor doubles the screen area so you can monitor more functions at once and have direct access to make adjustments when needed. You could, for example, view vehicle control functions on your primary display and Precision Ag applications on the Extended Monitor.



Electronic joystick

You will appreciate joystick-reversing and joystick-shifting for an optimal loader experience. The joystick is completely reconfigurable and controls all SCVs, front hitch and even ISOBUS functions.

Isobus—AEF certified

With Universal Terminal (UT) you can operate your implements, Task Controller Section Control (TC-SC) allows individual control of up to 255 sections. While TC-BAS enables documentation of totals in ISOXML data format, TC-GEO adds the capability for geo-referenced ISOXML documentation. AUX-N provides universal compatibility to the tractor joystick and CommandPRO™.



Power without limits

Get all the power you need with less fuel and lower emissions from our renowned 4.5 L 4 cylinder engine or the 6.8 L 6 cylinder engines (Stage V compliant). All our 6 cylinder engines feature extended drain intervals of up to 750 hours.*

Engine responsiveness

The diesel particulate filter (DPF) not only traps particles but also improves the transient response for better throttle responsiveness.

Selective catalytic reduction (SCR)

Diesel exhaust fluid is mixed with engine exhaust gases in the catalyst to further reduce NOx.

Cooled exhaust gas recirculation (EGR)

Precise amounts of cooled exhaust gases are mixed with incoming fresh air, lowering combustion temperatures. This leads to less NOx output from the engine and more efficient timing, which promotes both fuel and DEF economy.

Series turbochargers

The series turbochargers deliver more low-speed torque and engine responsiveness to meet varying load requirements.



Our 4.5 L PSS engines (6R 110, 6R 120, 6R 130, 6R 140 and 6R 150) use a 2-stage turbocharging system in which the Wastegate turbocharger multiplies the pressure created by a fixed vane turbocharger. This sequential arrangement boosts power to achieve up to 131 kW (177 hp, max with IPM) in the 6R 150.

* with John Deere Plus-50™ II

Long 750 hour oil change interval* and hydraulic IPM



6R 250

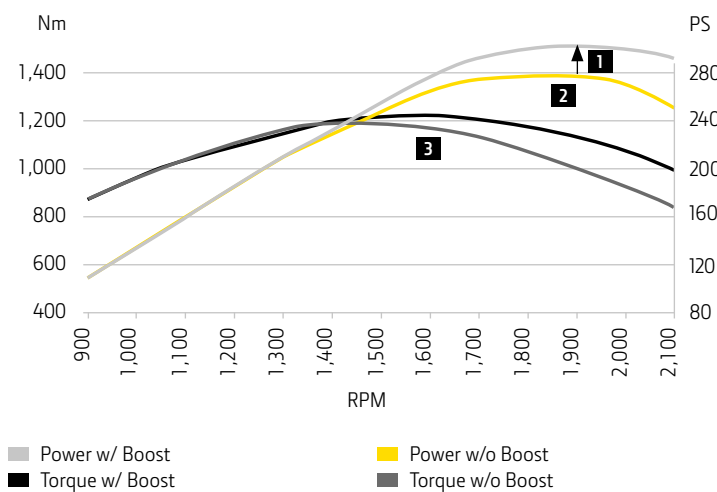

The higher power output of our 6-cylinder engines comes from refined 4-valve High Pressure Common Rail technology with injection pressure of up to 2,500 bar. The PVS engine in the 6R 145 – 6R 215 has a Variable Geometry Turbocharger that boosts performance and efficiency across the torque curve. The PSS engines (6R 230 and 6R 250) use a 2-stage turbocharging system in which the VGT multiplies the pressure created by a fixed vane turbocharger.

Intelligent Power Management (1) provides up to 30 additional kW (40 hp) for transport, hydraulic and PTO applications. Max. power (2) and max. torque (3) are achieved at 1,900 and 1,600 rpm respectively to ensure optimum response with low fuel consumption levels.

AutoQuad™ Plus

Compelling convenience

Equipped with either 20F/20R or 24F/24R speeds, left-hand reverser, and four powershiftable gears in five or six fully-synchronised ranges. AutoQuad PLUS transmissions have all the features of the time-proven and very popular PowrQuad™ PLUS transmission, plus many additional features.

Comfortable

An ergonomically-shaped lever comfortably supports the right hand and guides the thumb to the appropriate position for easy up and downshifting.

Auto shifting

Using the auto button, the transmission will automatically shift within the gear range depending on the load.

- 1** Gear shift buttons
- 2** Declutch button
- 3** Auto mode



CommandQuad™ Plus

Looking for that extra level of operational ease? Say hello to a lot less clutching and experience more productive days in the cab. You'll love the enhanced automatic capabilities of CommandQuad Plus.

Full auto mode

Seamless driving that combines automatic shifting with fuel savings at a high level of convenience.

Stop-and-go ease

The AutoClutch function lets you stop the tractor without pressing the clutch—it makes a huge difference if you do a lot of stop-and-go work.

Efficient multi-range shifting

Fully robotised gear and range shifting: no clutching required. Using the double-bump feature, you can shift up one range with a quick double bump (C1 to D1 for example).

- 1** Speed wheel
- 2** Shift lever
- 3** Automatic mode
- 4** Manual mode
- 5** Range selection



DirectDrive

Advanced dual clutch technology

Specifically developed for 6R tractors, DirectDrive is an eight-speed, three-range transmission designed and engineered by John Deere for heavy agricultural work.

1 Clutch 1: Shifting of even gears

2 Clutch 2: Shifting of odd gears



“Thanks to Auto Clutch, it is like driving a car with automatic transmission.”

PROFI (JUNE 2019)

Seamless efficiency

Dual-clutch technology always lines up the next gear so that no momentum is lost during changes—reducing fuel consumption and enhancing ease of operation.

Better fuel economy

During transport, DirectDrive reduces the engine speed to 1,550 rpm at 40 km/h and 1,600 rpm at 50 km/h for significantly reduced fuel consumption.

Stop-and-go ease

The AutoClutch function lets you stop the tractor without pressing the clutch—it makes a huge difference if you do a lot of stop and go work.

1 Speed wheel

4 Manual mode

2 Shift lever

5 Range selection

3 Automatic mode

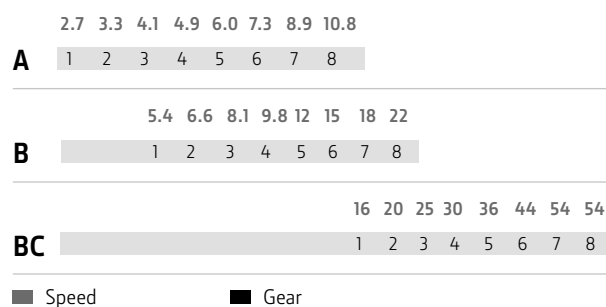

DirectDrive offers 11 gears between 4 and 12 km/h thus ensuring the optimum gear/rpm combination regardless of the situation.



AutoPower™

Infinite speed adjustment

AutoPower is a hydro-mechanical transmission that delivers stepless and continuous power at speeds between 50 m/h and 50 km/h.



Comfort

AutoPower maintains the selected speed by automatically responding to changing load conditions.

Fuel economy

Once running at maximum road speed, engine rpm automatically drops to the minimum level required to maintain that speed—reducing noise and saving fuel. 50 km/h is maintained at 1,630 rpm, 40 km/h at 1,300 rpm with CommandPRO™. AutoPower comes standard in 6R 230 and 6R 250 tractors.

Two control layouts

With AutoPower, superior efficiency comes as standard. Controlled with CommandPRO it also brings ultimate convenience.



- 1** Set-speed adjusting wheel
- 2** Speed band two
- 3** Speed band one

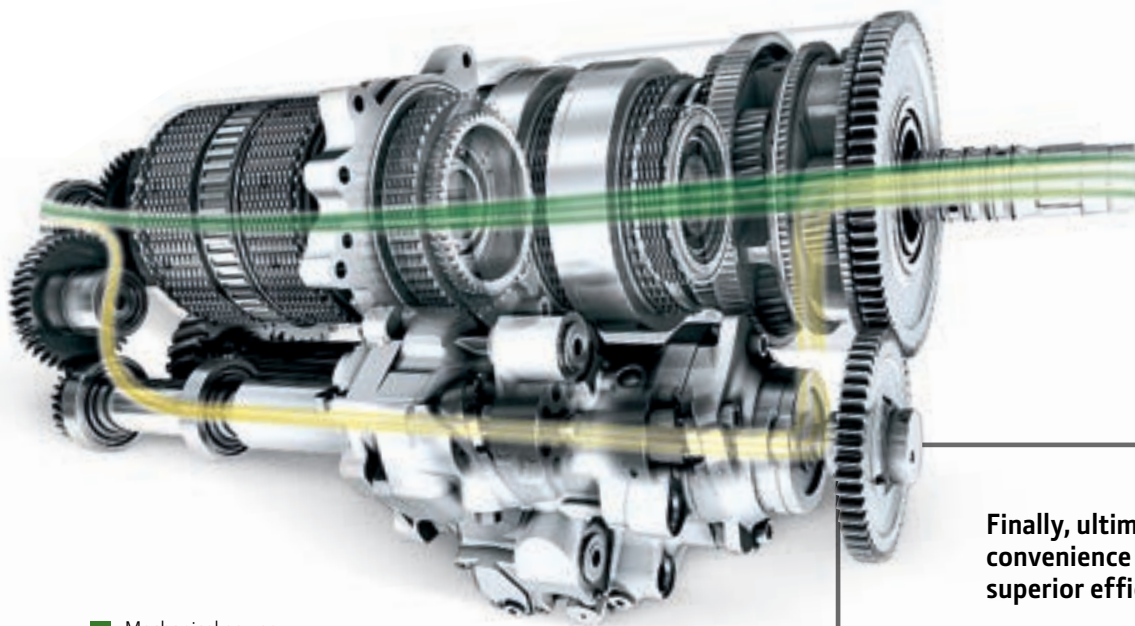

■ Mechanical power
 ■ Hydrostatic power

Finally, ultimate convenience also means superior efficiency

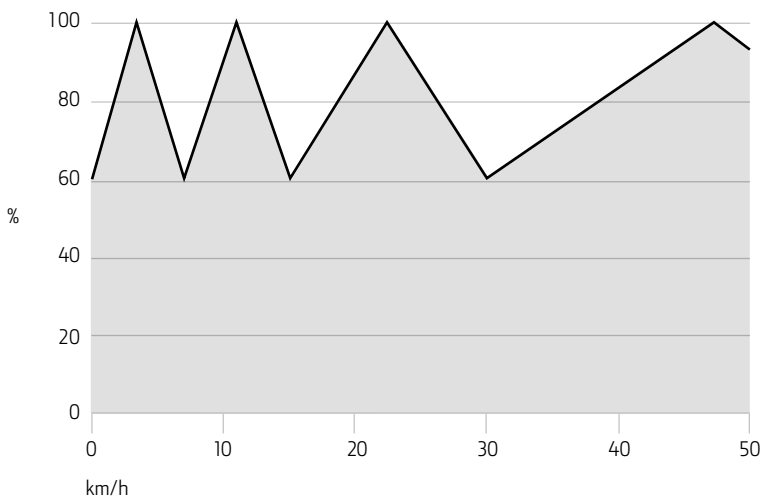

Maximum efficiency

AutoPowr delivers 100% mechanical power at the following working speeds: 3.5 km/h (heavy draft), 11 km/h (light draft), 22.5 km/h (heavy transport) and 47.2 km/h (light transport). This results in superb transmission efficiency, close to that of mechanical transmissions. In fact, AutoPowr is always using more than 60% of the available mechanical power.



Light up the night

Nature has never respected normal working hours. Keep your operations productive even at night, with 360° visibility provided by up to 12 cab lights.

Working after dark is nothing new to you. But now you can see your fields in a whole new light. Our factory-installed lighting packages cast the best light to work by all around your 6R Series. Or make working the night shift more productive than ever with our LED lighting packages. They consume less power, deliver brighter, daylight quality light and go the distance.

Pre-sets for productivity

Programming the Generation 4 CommandCenter™ for perfect night work lighting couldn't be easier.



Work lights are cleverly integrated into the front, rear and sides of the roofline to prevent damage from low branches.



Select Light Package

- 1** Six front grill-mounted halogen lights
- 2** Eight cab roof mounted halogen lights
- 3** Two beltline mounted turn lights

Premium Light Package

- 1** Six front grill-mounted halogen lights
- 2** Twelve cab roof mounted halogen lights (ten if combined with panorama roof selected)
- 3** Two beltline mounted turn lights
- 4** Two fender mounted brake and turn lights
- 5** Two fender mounted halogen lights
- 6** Footsteps lights on both sides

Ultimate Light Package

Same number of lights as in premium package. Halogen lights replaced by LED (except for 2 low beam road lights).

Optional

- 7** Two belt line work lights (Halogen or LED)
- 8** Two Belt line road lights (H4)
- 9** Single or dual beacon
- 10** Rear fender work lights (Halogen or LED)

Great ride, all the power

The Triple Link Suspension Plus not only guarantees optimum traction and field performance, it also applies up to 10% more power to the ground.

It also ensures higher operator comfort, reduces operator fatigue and increases productivity, while Variable Ratio Steering improves in-field manoeuvrability.

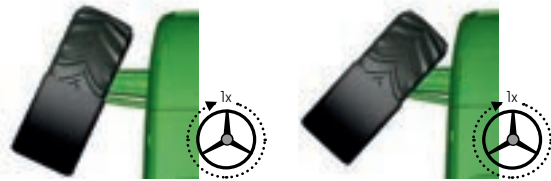

Variable Ratio Steering off

Variable Ratio Steering on

Variable Ratio Steering

Improves operator comfort, requiring less hand movement and less steering effort when turning on the headland or working with a loader in confined spaces. The resulting faster turning of the steering wheel increases hydraulic flow, leading to quicker response of the tyres. Available for all 6R models.



Enhanced operator comfort

The intelligent hydro-pneumatic cab suspension (HCS Plus) offers more driving comfort in the field and on the road. Input from the acceleration and TLS™ sensor causes the cab suspension controller to increase or decrease the amount of oil in the shock absorber ram. This semi-active system delivers ultimate comfort in every situation.

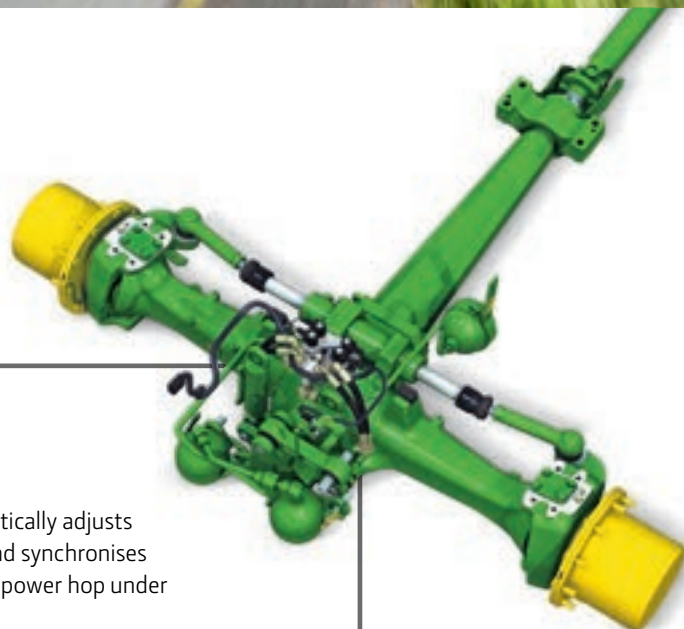

Adaptive front axle

The self-levelling TLS Plus automatically adjusts sensitivity and suspension rate, and synchronises with hitch sensing to compensate power hop under heavy pull conditions.

Get hitched to productivity

Experience the fusion of big pulling power with versatility across a broad variety of applications. 6R tractors offer a wide range of hitch, PTO and drawbar options, with all hitch parameters easily controlled from the CommandCenter™.

Rear PTO choices

An independent 3-speed electrically shifted rear PTO is standard on all 6R tractors. Choose between the 540/540E/1000 and the 540E/1000/1000E—now available for all 6Rs.



Powerful hitch options

6R tractors offer a variety of rear hitch options to complement application needs all the way up to 10,400 kg of pure lifting power.

Ball-type hitches

Fulfilling all customer requirements, these hitches provide optimum traction and driving dynamics for tractor/trailer combinations.

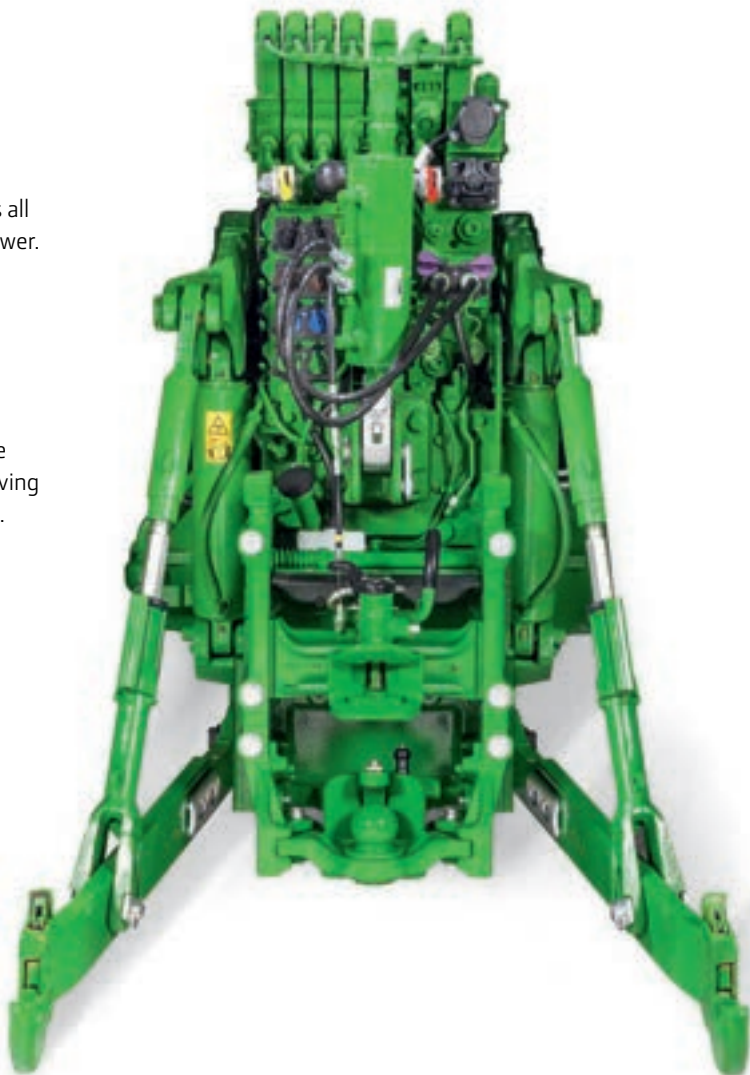

Big front hitch lift

Also available: a fully integrated front hitch with up to 5,900 kg maximum lift capacity. Plus, the 6R can also be ordered with an iTEC™ capable front PTO.



Smarter hydraulics

There's plenty of power to go around with the closed-centre, pressure and flow-compensated hydraulic system.

Hydraulic IPM

As a supplement to PTO and transport applications, Intelligent Power Management now also delivers additional horsepower for hydraulic driven implements. The hydraulic IPM keeps tractor wheel speed constant during applications that use power-hungry hydraulically driven implements, like slurry tankers, sprayers, or manure spreaders.

Power beyond

Power Beyond auxiliary hydraulic connections provide live hydraulic power to equipment. This enables the supply of hydraulic oil to implements with their own control valves or hydraulic motors (for example, on large air seeders or on planters). The system includes one motor return coupler, one flat-face sump coupler, one Power Beyond pressure coupler and one load sense coupler.



SCVs aplenty

In a 6R you get up to six electro-hydraulic selective control valves (SCVs)—with pressure relief lever, logically clustered, and all iTEC™ capable. You can easily control flow rates and times from the cab with the CommandCenter™.

Depending on power demand, up to 30 additional kW (40 hp) for hydraulic applications get released with IPM.





Front SCVs

For your hydraulic power requirements at the front, the front hitch can be ordered with up to two iTEC™ capable SCVs.

Hydraulic pumps

Definitely located at the upper end of the performance spectrum, the hydraulic pump of the 6R 230 and 6R 250 delivers an impressive flow of 160 L/min at only 1,500 RPM. All other models still produce a strong 114 L/min flow, and an optional 155 L/min pump is also available.

	114 L/min	155 L/min	160 L/min
6R 110 – 6R 120	■	–	–
6R 130 – 6R 215	■	□	–
6R 230 – 6R 250	–	–	■

■ base □ optional – not available

Maximise your day

Front loaders

Easy and quick to mount, our loaders are built for productivity—with perfect visibility and practically no maintenance. Whatever your needs, you'll find the right one right here.

John Deere R Series front loaders have our automatic latch designs, making the installation of loader and implements as easy as click and go. Our optional technology package boosts your productivity thanks to Return-to-Position, and further enhances precision with dynamic weighing, while preventing material losses thanks to the electronic Level-to-Horizon feature. And if you are looking for a light loader for occasional use, opt for our M Series loaders.



Dynamic weighing

Enhance your precision on the go: Our dynamic weighing system enables you to fill the bucket to the exact desired weight and lets you create step by step wagon-filling recipes.



Return-to-Position

Boost your productivity for repetitive tasks. With Return-to-Position you can save up to four implement positions for quick and comfortable recall with the joystick.



Level-to-Horizon

Prevent material losses while keeping your speed. The Level-to-Horizon feature keeps the implement levelled in uneven terrain.

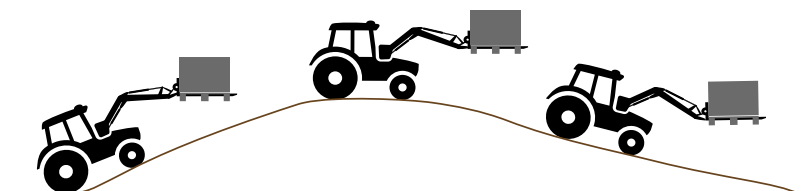



Born to perform

The 6R delivers a new level of performance. Its advanced Pressure and Flow Compensated (PFC) hydraulic system produces a flow of up to 160 L/min for more power and faster cycle times than you have ever experienced before in this tractor class.

Electronic joystick with reverser

Easily the most comfortable way to operate a front loader: the new reverser on the joystick lets you change the tractor's direction with the push of a button and shift gears on buttons 5 or 6.

Tractor/loader compatibility

Four R Loader models are available for the 6R tractors.

	623R	643R	663R	683R
6R 110-6R 150	■	■	-	-
6R 145-6R 185	-	■	■	-
6R 175-6R 215	-	-	■	■
6R 230, 6R 250	-	-	-	■

- 1 Loader suspension system (default assignment)
- 2 Lock/unlock joystick
- 3 Rocker switch for three independent function operations
- 4 Reverser
- 5 Gearshift button, upshift (default assignment)
- 6 Gearshift button, downshift (default assignment)
- 7 First diverter button (default assignment)
- 8 Second diverter button (default assignment)
- 9 Record weighing (default assignment)

Specifications

Models	6R 110	6R 120	6R 130	6R 140	6R 150
Engine					
Rated power (ECE-R120), kW (hp)	81 (110)	88 (120)	96 (130)	103 (140)	110 (150)
Rated power with IPM (ECE-R120) @ 2,100 rpm, kW (hp)	96 (130)	103 (140)	110 (150)	118 (160)	125 (170)
Max engine power (ECE-R120), kW (hp)	89 (121)	97 (132)	105 (143)	113 (154)	121 (165)
Max engine power with IPM (ECE-R120), kW (hp)	99 (135)	107 (145)	115 (156)	122 (166)	130 (177)
Constant power range, rpm	2,100 – 1,500	2,100 – 1,500	2,100 – 1,500	2,100 – 1,500	2,100 – 1,500
Torque rise, percentage	40	40	40	40	40
Maximum torque, Nm (at 1,600 engine rpm)—without boost	515	562	609	656	702
Maximum torque, Nm (at 1,600 engine rpm)—with boost	543	585	627	669	711
Rated speed, rpm	2,100	2,100	2,100	2,100	2,100
Manufacturer	John Deere Power Systems				
Type	PowerTech™ PSS				
Aftertreatment	Lifetime Diesel Particulate Filter (DPF), Diesel Oxidation Catalyst (DOC) and Selective Catalytic Reduction (SCR) using DEF				
Engine air filter	PowerCore® air filter with pre-cleaning				
Aspiration	Dual turbochargers, wastegate turbo with fixed geometry turbo in series				
Cylinders/Displacement	4/4.5 L	4/4.5 L	4/4.5 L	4/4.5 L	4/4.5 L
Cooling system	Stacked cooling system				
Fuel injection system and control	High pressure common rail system with up to 2,000 bar injection pressure, electronically controlled				
Transmissions					
AutoQuad™ Plus					
20/20 2.7 – 40 km/h	–	–	–	–	–
24/24 1.8 – 40 km/h	■	■	■	■	–
20/20 2.7 – 50 km/h	–	–	–	–	–
24/24 1.8 – 50 km/h	■	■	■	■	–
AutoQuad™ Plus Ecoshift					
20/20 2.7 – 40 km/h	–	–	–	–	–
24/24 1.8 – 40 km/h	■	■	■	■	–
Creeper (AutoQuad™ Plus and AutoQuad™ Plus Ecoshift)	■	■	■	■	–
CommandQuad™ Plus					
24/24 1.8 – 40 km/h	■	■	■	■	–
24/24 1.8 – 50 km/h	■	■	■	■	–
CommandQuad™ Plus Ecoshift					
24/24 1.8 – 40 km/h	■	■	■	■	–
DirectDrive					
24/24 2.8 – 40 km/h	–	–	–	–	–
24/24 2.8 – 50 km/h	–	–	–	–	–
AutoPowr™					
0.05 – 40 km/h	■	■	■	■	■
0.05 – 50 km/h	■	■	■	■	■
Axles					
Suspended front axle (option)	Triple Link Suspension (TLS™ Plus) MFWD Axle, hydro-pneumatic, permanently active, triple link, self-levelling, load adjusting suspension				
Suspension range with TLS™ Plus	100 mm suspension range				
Engagement front differential lock	Self-locking differential				
Engagement rear differential lock	Electro-hydraulic with oil cooled clutch				
Rear axle	Flange or R&P axle				
Steering					
Type	Hydrostatic, Variable Ratio Steering optional				
Hydraulic System					
Type	Pressure and Flow Compensated (PFC) system with load sensing function				
Flow at rated engine speed base/option, L/min	114	114	114	114/155	114/155
Selective control valves	Up to 5+3	Up to 5+3	Up to 5+3	Up to 5+3	Up to 5+3
Power beyond	Optional	Optional	Optional	Optional	Optional
Oil take out capacity with overfill, L	25	25	25	25	25
Oil take out capacity with additional oil reservoir, L	32	32	32	32	32

*The engine horsepower and torque information are provided by the engine manufacturer to be used for comparison purposes only. Actual operating horsepower and torque will be less. Refer to the engine manufacturer's website for additional information.

Air Conditioning Systems contain R134a, a Fluorinated Greenhouse Gas, with a Global Warming Potential of 1430.

Models	6R 110	6R 120	6R 130	6R 140	6R 150
3-point hitch—rear					
Type	Electronic lower link sensing; load & depth control, infinite mix, float				
Category	2/3N	2/3N	2/3N	3N	3N
Maximum lift capacity at hooks, kg	6,800	6,800	6,800	6,800	6,800
Lift capacity through full lift range (OECD 610 mm), kg	4,350	4,350	4,350	4,350	4,350
Lift capacity through full lift range (OECD 1,800 mm), kg	2,660	2,660	2,660	2,660	2,660
3-point hitch—front, optional					
Type	Front hitch controlled by rear SCV (Select option) or dedicated SCV (Premium or Ultimate option)				
Category	3N	3N	3N	3N	3N
Maximum lift capacity at hooks, kg	4,000	4,000	4,000	4,000	4,000
Lift capacity through full lift range (OECD at the hooks), kg	3,300	3,300	3,300	3,300	3,300
Rear PTO					
Type	Electro-hydraulically engaged, oil cooled, multi-disc design				
Engine rpm at rated PTO speeds with 540/540E/1,000 option	1,967/1,496/1,962	1,967/1,496/1,962	1,967/1,496/1,962	1,967/1,496/1,962	1,967/1,496/1,962
Engine rpm at rated PTO speeds with 540E/1,000/1,000E option	1,565/1,967/1,655	1,565/1,967/1,655	1,565/1,967/1,655	1,565/1,967/1,655	1,565/1,967/1,655
Front PTO, Optional					
Type	Electro-hydraulically engaged, oil cooled				
Engine speed at rated PTO speed (1,000), rpm	1,969	1,969	1,969	1,969	1,969
Cab					
Specifications	ComfortView™ cab with 2 panorama doors or B-Post on left hand side and Generation 4 CommandCenter™ Display				
Suspension (option)	Adaptive hydraulic cab suspension HCS Plus				
Noise level at operator's ear, dB(A)	71	71	71	71	71
Cab glass area, m ²	6.11	6.11	6.11	6.11	6.11
Cab volume, m ³	3.33	3.33	3.33	3.33	3.33
Display	Generation 4 CommandCenter™ 4200 8.4" or 4600 10.4" Display				
Miscellaneous					
AutoTrac™ Ready	Optional				
ISOBUS ready	Optional				
CommandCenter™ video inputs	1 input for 4200 8.4" Display, 4 inputs for 4600 10.4" Display				
Immobiliser	Optional				
Trailer brake systems (options)	Hydraulic and/or pneumatic system				
Pneumatic trailer brake system (option)	Hydraulic retarding valve, air drier included				
Connectivity					
JDLINK™	In Base				
Remote Machine Monitoring (incl. Expert Alerts)	In Base				
Capacities					
Fuel tank (base/option), L	199/225	199/225	199/225	199/225	199/225
DEF, L	13.5	13.5	13.5	13.5	13.5
Engine coolant, L	22	22	22	22	22
Dimensions and weights					
Wheelbase, mm	2,580	2,580	2,580	2,580	2,580
Width × Height × Length, mm	2,430 × 2,910 × 4,540				
<i>Measured with flanged axle, up to cab roof, from front weight support to horizontal draft link hooks and with max. front tyres / max. rear tyre sizes</i>					
Ground clearance, mm	481	481	506	506	506
<i>Measured at centre of front axle, using max. front and max. rear tyre sizes</i>					
Shipping weight, kg	6,500	6,500	6,500	6,500	6,500
<i>Measured with average specifications</i>					
Maximum permissible gross weight, kg	10,450	10,450	10,450	10,450	10,450
Tyre sizes					
Front tyre sizes, max. available	520/60R28	520/60R28	540/65R28	540/65R28	540/65R28
Rear tyre sizes, max. available	650/60R38	650/60R38	650/65R38	650/65R38	650/65R38

Specifications

Models	6R145	6R155	6R165	6R185
Engine				
Rated power (ECE-R120), kW (hp)	107 (145)	114 (155)	121 (165)	136 (185)
Rated power with IPM (ECE-R120) @ 2,100 rpm, kW (hp)	136 (185)	143 (195)	151 (205)	165 (225)
Max engine power (ECE-R120), kW (hp)	117 (160)	125 (171)	133 (182)	150 (204)
Max engine power WITH IPM (ECE-R120), kW (hp)	141 (192)	149 (203)	157 (213)	172 (234)
Constant power range, rpm	2,100 – 1,500	2,100 – 1,500	2,100 – 1,500	2,100 – 1,500
Torque rise, percentage	40	40	40	40
Maximum torque, Nm (at 1,600 engine rpm)—without boost	679	726	773	866
Maximum torque, Nm (at 1,600 engine rpm)—with boost	773	815	842	941
Rated speed, rpm	2,100	2,100	2,100	2,100
Manufacturer	John Deere Power Systems			
Type	PowerTech™ PVS			
Aftertreatment	Lifetime Diesel Particulate Filter (DPF), Diesel Oxidation Catalyst (DOC) and Selective Catalytic Reduction (SCR) using DEF			
Engine air filter	PowerCore® air filter with pre-cleaning			
Aspiration	Single variable geometry turbocharger			
Cylinders/Displacement	6/6.8 L			
Cooling system	Stacked cooling system	Stacked cooling system	Stacked cooling system	Distributed cooling system with temperature controlled viscous fan drive and dedicated fan for charge air cooling
Fuel injection system & control	High pressure common rail system with up to 2,500 bar injection pressure, electronically controlled			
Transmissions				
AutoQuad™ Plus				
20/20 2.7 – 40 km/h	■	■	–	–
24/24 1.8 – 40 km/h	–	–	–	–
20/20 2.7 – 50 km/h	■	■	–	–
24/24 1.8 – 50 km/h	–	–	–	–
AutoQuad™ Plus Ecoshift				
20/20 2.7 – 40 km/h	■	■	–	–
24/24 1.8 – 40 km/h	–	–	–	–
Creeper (AutoQuad™ Plus and AutoQuad™ Plus Ecoshift)	■	■	–	–
CommandQuad™ Plus				
24/24 1.8 – 40 km/h	–	–	–	–
24/24 1.8 – 50 km/h	–	–	–	–
CommandQuad™ Plus Ecoshift				
24/24 1.8 – 40 km/h	–	–	–	–
DirectDrive				
24/24 2.8 – 40 km/h	■	■	■	–
24/24 2.8 – 50 km/h	■	■	■	–
AutoPowr™				
0.05 – 40 km/h	■	■	■	■
0.05 – 50 km/h	■	■	■	■
Axles				
Suspended front axle (option)	Triple Link Suspension (TLS™ Plus) MFWD Axle, hydro-pneumatic, permanently active, triple link, self-levelling, load adjusting suspension			
Suspension range with TLS™ Plus	100 mm suspension range	100 mm suspension range	100 mm suspension range	100 mm suspension range
Engagement front differential lock	Self-locking differential	Self-locking differential	Self-locking differential	Self-locking differential
Engagement rear differential lock	Electro-hydraulic with oil cooled clutch	Electro-hydraulic with oil cooled clutch	Electro-hydraulic with oil cooled clutch	Electro-hydraulic with oil cooled clutch
Rear axle	Flange or R&P axle	Flange or R&P axle	Flange or R&P axle	Flange or R&P axle
Steering				
Type	Hydrostatic, Variable Ratio Steering optional	Hydrostatic, Variable Ratio Steering optional	Hydrostatic, Variable Ratio Steering optional	Hydrostatic, Variable Ratio Steering optional

Models	6R 145	6R 155	6R 165	6R 185
Hydraulic system				
Type	Pressure & Flow Compensated (PFC) system with load sensing function			
Flow at rated engine speed base/option, L/min	114/155	114/155	114/155	114/155
Selective control valves	Up to 6+3	Up to 6+3	Up to 6+3	Up to 6+3
Power beyond	Optional	Optional	Optional	Optional
Oil take out capacity with overfill, L	39	39	39	39
Oil take out capacity with additional oil reservoir, L	45	45	45	45
3-point hitch—rear				
Type	Electronic lower link sensing; load & depth control, infinite mix, float			
Category	3/3N	3/3N	3/3N	3/3N
Maximum lift capacity at hooks, kg	8,100	8,100	8,100	8,100
Lift capacity through full lift range (OECD 610 mm), kg	4,200	4,200	4,200	4,200
Lift capacity through full lift range (OECD 1,800 mm), kg	3,200	3,200	3,200	3,200
3-point hitch—front, optional				
Type	Front hitch controlled by rear SCV (Select option) or dedicated SCV (Premium or Ultimate option)			
Category	3N	3N	3N	3N
Maximum lift capacity at hooks, kg	4,000	4,000	4,000	4,000
Lift capacity through full lift range (OECD at the hooks), kg	3,300	3,300	3,300	3,300
Rear PTO				
Type	Electro-hydraulically engaged, oil cooled, multi-disc design			
Engine rpm at rated PTO speeds with 540/540E/1,000 option	1,987/1,753/2,000	1,987/1,753/2,000	1,987/1,753/2,000	1,987/1,753/2,000
Engine rpm at rated PTO speeds with 540E/1,000/1,000E option	1,567/1,970/1,657	1,567/1,970/1,657	1,567/1,970/1,657	1,567/1,970/1,657
Front PTO, optional				
Type	Electro-hydraulically engaged, oil cooled			
Engine speed at rated PTO speed (1,000), rpm	1,969	1,969	1,969	1,969
Cab				
Specifications	ComfortView™ cab with 2 panorama doors or B-Post on left hand side and Generation 4 CommandCenter™ Display			
Suspension (option)	Adaptive hydraulic cab suspension HCS Plus			
Noise level at operator's ear, dB(A)	71	71	71	71
Cab glass area, m ²	6.11	6.11	6.11	6.11
Cab volume, m ³	3.33	3.33	3.33	3.33
Display	Generation 4 CommandCenter™ 4200 8.4" or 4600 10.4" Display			
Miscellaneous				
AutoTrac™ Ready	Base			
ISOBUS ready	Optional			
CommandCenter™ video inputs	1 input for 4200 8.4" Display, 4 inputs for 4600 10.4" Display			
Immobiliser	Optional			
Trailer brake systems (options)	Hydraulic and/or pneumatic system			
Pneumatic trailer brake system (option)	Hydraulic retarding valve, air drier included			
Connectivity				
JDLINK™	In Base			
Remote Machine Monitoring (incl. Expert Alerts)	In Base			
Capacities				
Fuel tank (base/option), L	280/322	280/322	280/322	280/322
DEF, L	16	16	16	16
Engine coolant, L	27.4	27.4	27.4	27.4
Dimensions and weights				
Wheelbase, mm	2,765	2,765	2,765	2,765
Width × Height × Length, mm	2,490 × 2,950 × 4,930			
<i>Measured with flanged axle, up to cab roof, from front weight support to horizontal draft link hooks and with max. front tyres / max. rear tyre sizes</i>				
Ground clearance, mm	553	553	553	553
<i>Measured at centre of front axle, using max. front and max. rear tyre size</i>				
Shipping weight, kg	7,900	7,900	7,900	7,900
<i>Measured with average specifications</i>				
Maximum permissible gross weight, kg	11,750	11,750	11,750	11,750
Tyre sizes				
Front tyre sizes, max. available	600/65R28	600/65R28	600/65R28	600/65R28
Rear tyre sizes, max. available	710/70R38	710/70R38	710/70R38	710/70R38

Specifications

Models	6R 175	6R 195	6R 215	6R 230	6R 250
Engine					
Rated power (ECE-R120), kW (hp)	129 (175)	143 (195)	158 (215)	169 (230)	184 (250)
Rated power with IPM (ECE-R120) @ 2,100 rpm, kW (hp)	158 (215)	173 (235)	188 (255)	199 (270)	213 (290)
Max engine Power (ECE-R120), kW (hp)	142 (193)	158 (215)	174 (237)	186 (253)	202 (275)
Max engine Power WITH IPM (ECE-R120), kW (hp)	164 (223)	180 (244)	190 (259)	206 (281)	222 (301)
Constant power range, rpm	2,100 – 1,500	2,100 – 1,500	2,100 – 1,500	2,100 – 1,500	2,100 – 1,500
Torque rise, percentage	40	40	40	40	40
Maximum torque, Nm (at 1,600 engine rpm) – without boost	819	913	1,007	1,077	1,171
Maximum torque, Nm (at 1,600 engine rpm) – with boost	899	982	1,025	1,129	1,212
Rated speed, rpm	2,100	2,100	2,100	2,100	2,100
Manufacturer	John Deere Power Systems				
Type	PowerTech™ PVS		PowerTech™ PSS		
Aftertreatment	Lifetime Diesel Particulate Filter (DPF), Diesel Oxidation Catalyst (DOC) and Selective Catalytic Reduction (SCR) using DEF				
Engine air filter	PowerCore® air filter with pre-cleaning		External A-Post Filter with pre-cleaning		
Aspiration	Single variable geometry turbocharger		Dual turbochargers, variable geometry turbo with fixed geometry turbo in series		
Cylinders/Displacement	6/6.8 L				
Cooling system	Distributed cooling system with temperature controlled viscous fan drive and dedicated fan for charge air cooling				
Fuel injection system & control	High pressure common rail system with up to 2,500 bar injection pressure, electronically controlled				
Transmission					
AutoQuad™ Plus					
20/20 2.7 – 40 km/h	■	■	■	–	–
20/20 2.9 – 50 km/h	■	■	■	–	–
AutoQuad™ Plus Ecoshift					
20/20 2.9 – 40 km/h	■	■	■	–	–
DirectDrive					
24/24 2.7 – 40 km/h	■	■	■	–	–
24/24 2.7 – 50 km/h	■	■	■	–	–
AutoPowr™					
0.05 – 40 km/h	■	■	■	■	■
0.05 – 50 km/h	■	■	■	■	■
Axles					
Suspended front axle	Triple Link Suspension (TLS™ Plus) MFWD Axle in base; hydro-pneumatic, permanently active, triple link, self-levelling, load adjusting suspension			Braked Triple Link Suspension (TLS™ Plus) MFWD Axle in base; hydro-pneumatic, permanently active, triple link, self-levelling, load adjusting suspension	
Suspension range with TLS™ Plus	100 mm suspension range	100 mm suspension range	100 mm suspension range	100 mm suspension range	100 mm suspension range
Engagement front differential lock	Self-locking differential; 100% differential lock optional	Self-locking differential; 100% differential lock optional	Self-locking differential; 100% differential lock optional	100% differential lock in base	100% differential lock in base
Engagement rear differential lock	Electro-hydraulic with oil cooled clutch				
Rear axle	Flange axle or rack and pinion axle				
Steering					
Type	Hydrostatic, Variable Ratio Steering optional				
Hydraulic system					
Type	Pressure and Flow Compensated (PFC) system with load sensing function				
Flow at rated engine speed base/option, L/min	114/155	114/155	114/155	160	160
Selective control valves	Up to 6+3	Up to 6+3	Up to 6+3	Up to 6+3	Up to 6+3
Power beyond	Optional	Optional	Optional	Optional	Optional
Oil take out capacity with overfill, L	47	47	47	47	47
Oil take out capacity with additional oil reservoir, L	55	55	55	80	80

Models	6R 175	6R 195	6R 215	6R 230	6R 250
3-Point Hitch—rear					
Type	Electronic lower link sensing; load and depth control, infinite mix, float				
Category	3/3N				
Maximum lift capacity at hooks, kg	9,550	9,550	9,550	10,400	10,400
Lift capacity through full lift range (OECD 610 mm), kg	5,450	5,450	5,450	7,000	7,000
Lift capacity through full lift range (OECD 1,800 mm), kg	3,800	3,800	3,800	4,300	4,300
3-Point Hitch—front, optional					
Type	Front hitch controlled by rear SCV (Select option) or dedicated SCV (Premium or Ultimate option)			Front hitch controlled by dedicated SCV in base	
Category	3N	3N	3N	3N	3N
Maximum lift capacity at hooks, kg	4,000	4,000	4,000	5,900	5,900
Lift capacity through full lift range (OECD at the hooks), kg	3,300	3,300	3,300	4,400	4,400
Rear PTO					
Type	Electro-hydraulically engaged, oil cooled, multi-disc design				
Engine rpm at rated PTO speeds with 540/540E/1,000 option	1,950/1,721/1,950	1,950/1,721/1,950	1,950/1,721/1,950	1,950/1,721/1,950	1,950/1,721/1,950
Engine rpm at rated PTO speeds with 540E/1,000/1,000E option	1,761/1,989/1,756	1,761/1,989/1,756	1,761/1,989/1,756	1,618/2,012/1,659	1,618/2,012/1,659
Front PTO, Optional					
Type	Electro-hydraulically engaged, oil cooled				
Engine speed at rated PTO speed (1,000), rpm	1.969	1.969	1.969	1.965	1.965
Cab					
Specifications	ComfortView™ cab with 2 panorama doors or B-Post on left hand side and Generation 4 CommandCenter™ Display				
Suspension (option)	Adaptive hydraulic cab suspension HCS Plus				
Noise level at operator's ear, dB(A)	71	71	71	71	71
Cab glass area, m ²	6.11	6.11	6.11	6.11	6.11
Cab volume, m ³	3.33	3.33	3.33	3.33	3.33
Display	Generation 4 CommandCenter™ 4200 8.4" or 4600 10.4" Display				
Miscellaneous					
AutoTrac™ Ready	Base	Base	Base	Base	Base
ISOBUS ready	Base	Base	Base	Base	Base
CommandCenter™ video inputs	1 input for 4200 8.4" Display, 4 inputs for 4600 10.4" Display				
Immobiliser	Optional	Optional	Optional	Optional	Optional
Trailer brake systems (options)	Hydraulic and/or pneumatic system				
Pneumatic trailer brake system (option)	Hydraulic retarding valve, air drier included				
Connectivity					
JDLINK™	In base	In base	In base	In base	In base
Remote Machine Monitoring (incl. Expert Alerts)	In base	In base	In base	In base	In base
Capacities					
Fuel tank (base /option), L	324/421	324/421	324/421	410/470	410/470
DEF, L	20	20	20	25	25
Engine coolant, L	28	28	28	34	34
Dimensions and Weights					
Wheelbase, mm	2,800	2,800	2,800	2,900	2,900
Width × Height × Length, mm	2,550 × 3,160 × 5,050	2,550 × 3,160 × 5,050	2,550 × 3,160 × 5,050	2,550 × 3,250 × 5,190	2,550 × 3,250 × 5,190
<i>Measured with flanged axle, up to cab roof, from front weight support to horizontal draft link hooks and with max. front tyres / max. rear tyre sizes</i>					
Height from centre of rear axle to top of cab (no beacon light), mm	2,183	2,183	2,183	2,183	2,183
Turning radius, m	5.62	5.62	5.62	5.62	5.62
<i>According to ISO789-3 measured for 600/65R30 at 2,050 mm tread setting and 1.6 bar inflation pressure on level ground</i>					
Shipping weight, kg	8,800	8,800	8,800	8,800	8,800
<i>Measured with average specifications</i>					
Maximum permissible gross weight, kg	13,450	13,450	13,450	13,450	13,450
Tyre Sizes					
Front tyre sizes, max. available	600/70 R28	600/70 R28	600/70 R28	600/70 R28	600/70 R28
Rear tyre sizes, max. available	800/70R38	800/70R38	800/70R38	800/70R38	800/70R38

Loader specifications

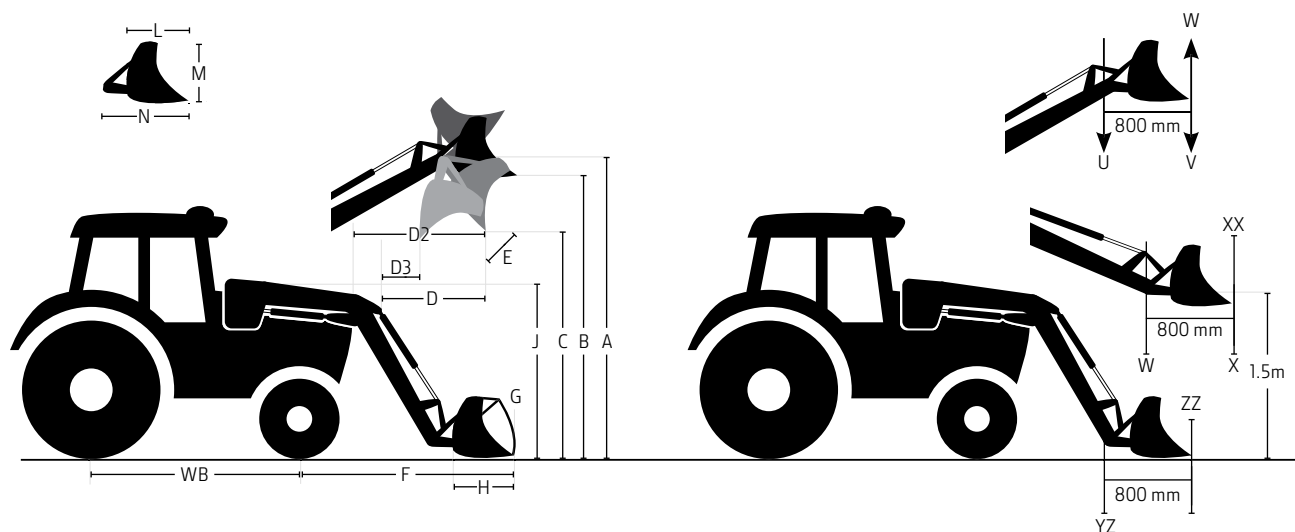

Small frame 6R

6R 110 / 6R 120 / 6R 130 / 6R 140 / 6R 150

Loader model	623M	643M	623R	623R	643R	643R
Levelling system	MSL	MSL	NSL*	MSL	NSL*	MSL
Front tyre	540/65R24	540/65R24	480/70R24	480/70R24	480/70R24	480/70R24
Rear tyre	600/65R38	600/65R38	520/70R38	520/70R38	520/70R38	520/70R38
Loader						
Bucket, mm	Standard 2,200	Standard 2,200	Standard 1,850	Standard 1,850	Heavy Duty 2,200	Heavy Duty 2,200
Bucket weight, kg	244	244	236	236	310	310
Lift capacity at full height (measured at 800 mm ahead of pivot), kg (V)	1,765	1,918	1,757	2,272	1,770	2,330
Maximum lift height, mm/ in (A)	162 / 4,120	4,159 / 164	4,124 / 162	4,124 / 162	4,151 / 163	4,151 / 163
Reach at maximum height, mm/ in (D)	30 mm / 752 in (D)	920 / 36	759 / 30	759 / 30	982 / 39	982 / 39
Cycle times (Loader raise), sec	6.6	4.5	3.4	3.4	3.5	3.3

Mid frame 6R

6R 145 / 6R 155 / 6R 165 / 6R 185

Loader model	643M	643R	643R	663R	663R
Levelling system	MSL	NSL*	MSL	NSL*	MSL
Front tyre	480/70R28	480/70R28	480/70R28	540/65R28	540/65R28
Rear tyre	580/70R38	580/70R38	580/70R38	650/65R38	650/65R38
Loader					
Bucket, mm	Standard 2,200	Heavy Duty 2,150	Heavy Duty 2,150	Heavy Duty 2,450	Heavy Duty 2,450
Bucket weight, kg	244	310	310	355	355
Lift capacity at full height (measured at 800 mm ahead of pivot), kg (V)	1,875	1,817	2,279	1,844	2,327
Maximum lift height, mm/ in (A)	4,300 / 169	4,300 / 169	4,300 / 169	4,495 / 177	4,495 / 177
Reach at maximum height, mm/ in (D)	638 / 25	841 / 33	841 / 33	1,026 / 40	1,026 / 40
Cycle times (Loader raise), sec	4.7	3.7	3.5	4.0	4.0

The values may vary according to the tractor and loader settings/configuration.

*Due to legislation, NSL loaders are not compliant in Australia.

Need more details?

Visit the frontloader section of the John Deere website.



The American Society of Agricultural and Biological Engineers is an educational and scientific organization dedicated to the advancement of engineering applicable to agricultural, food, and biological systems. Founded in 1907 and headquartered in St. Joseph, Michigan, ASABE comprises 8,000 members in more than 100 countries.

Large frame 6R		6R 175 / 6R 195 / 6R 215	
Loader model	663R	663R	683R
Levelling system	NSL*	MSL	MSL
Front tyre	600/65R28	600/65R28	600/65R28
Rear tyre	710/70R38	710/70R38	710/70R38
Loader			
Bucket, mm	Heavy Duty 2,450	Heavy Duty 2,450	Heavy Duty 2,450
Bucket weight, kg	356	356	356
Lift capacity at full height (measured at 800 mm ahead of pivot), kg (V)	1,857	2,352	2,506
Maximum lift height, mm/ in (A)	4,520 / 178	4,520 / 178	4,480 / 176
Reach at maximum height, mm/ in (D)	1,004 / 40	1,004 / 40	1,335 / 53
Cycle times (Loader raise), sec	4.0	3.9	4.2

Xtra large frame 6R		6R 230 / 6R 250	
Loader model		683R	
Levelling system		MSL	
Front tyre		600/70R30	
Rear tyre		650/85R38	
Loader			
Bucket, mm		Heavy Duty 2,450	
Bucket weight, kg		356	
Lift capacity at full height (measured at 800 mm ahead of pivot), kg (V)		2,538	
Maximum lift height, mm/ in (A)		4,520 / 178	
Reach at maximum height, mm/ in (D)		1,215 / 48	
Cycle times (Loader raise), sec		4.2	

Nothing runs like a Deere™

Chances are that when you need us, you need us right then and there. For advice, to solve a problem, or for a part. Reach out, we'll be there with technicians who are factory trained, ready to go to work for you, using only genuine John Deere parts and products. Our commitment to quality doesn't stop at your machine—we also have financing options available that are guaranteed to fit your budget and your plans.



JOHN DEERE

This literature has been compiled for worldwide circulation. While general information, pictures and descriptions are provided, some illustrations and text may include finance, credit, insurance, product options and accessories NOT AVAILABLE in all countries or regions. In some countries, products and accessories may require modifications or additions to ensure compliance with the local regulations of those countries. PLEASE CONTACT YOUR LOCAL DEALER FOR DETAILS. John Deere reserves the right to change specification and design of all products described in this literature without notice. John Deere's green and yellow colour scheme, the leaping deer symbol, and JOHN DEERE are trademarks of Deere & Company. All photography and illustrations contained herein are copyrighted assets of Deere & Company.

JohnDeere.com.au
JohnDeere.co.nz