

6M



JOHN DEERE

NOTHING RUNS LIKE A DEERE

INSTANT PRODUCTIVITY

THE 6M: POWERFUL. FAST. INTUITIVE.

No fuss, all the power you need and faster—the 6M experience is all about getting things done. These powerful tractors are cost-effective to own, supremely easy to operate from the get-go and will have you zipping along at up to 50 km/h. Built for those who go beyond the ordinary.

MAXIMUM DURABILITY

The John Deere full-frame design forms the rugged backbone of all 6 Series tractors. Engine and transmission are mounted within the frame on insulating blocks that reduce stress and operating noise. It's the perfect platform for a John Deere front loader.

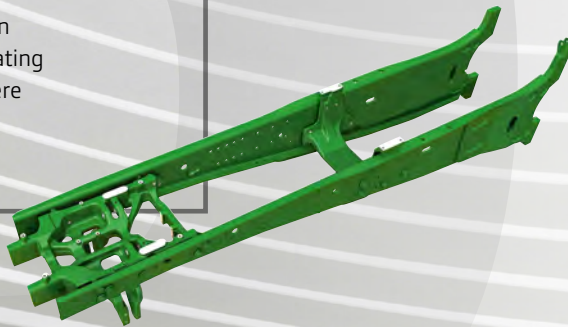

CONTENTS

Introduction 2



OVERVIEW

6M: Just the Facts 4

6M Short Frame Tractors 8

6M Small Frame Tractors 10

6M Mid Frame Tractors 12

6M Large Frame Tractors 14

6M Xtra Large Frame Tractors 16



CAB

Cab Comfort 18

Controls 22

Visibility 24



PRECISION FARMING

Precision Ag on demand 26

Site-specific farming 30



POWER & EFFICIENCY

Engines 32

Transmissions 34



VERSATILITY

Ride Comfort 39

Hydraulics and PTO 40

Axles 42

Front Loaders 44

COMPLETE SOLUTION



PowerGard Protection Plan™ 50

SPECIFICATIONS



Specifications 52



6M: JUST THE FACTS

NOTABLE FEATURES

There is a 6M for any job. Select your tractor from 13 high-performance models in five wheel bases.



VERSATILITY CHAMPION™

Finding your 6M is easy. Whether you are a livestock farmer, arable farmer, mixed farmer or run a contracting business, one of these tractors was made for you.

1 | SEE-MUCH-MORE CAB

The thoughtful internal and external design puts a premium on visibility—with more glass than ever and a lower hood for ultimate front visibility on the 6M 95, 6M 105 and 6M 125.

2 | MAKE IT YOURS

Featuring eSCV or mSCV controls, the right-hand console or the Compact CommandARM™, in conjunction with the Corner Post Display, allows you to customise your 6M to fit your individual needs perfectly.

3 | TRANSMISSION CHOICES

Your high-efficiency options include PowerQuad Plus, AutoQuad™ Plus, CommandQuad™ Plus and AutoPowr™. Get any job done faster with the optional 50 kph transmission.

7 | FIRST-CLASS COMFORT

You can look forward to the best ride experience ever—thanks to optional TLS™ front axle suspension and mechanical cab suspension.

8 | PRECISION AG ON DEMAND

Add a 10.1" or 12.8" G5™/G5^{Plus} Universal Display with effortless ISOBUS implement connectivity, AutoTrac™ and Section Control, and you're 100% Precision Ag-ready.

9 | ALWAYS UP-TO-DATE

JDLink™ enables remote operator support and ensures your tractor always gets the latest over-the-air software updates. Thanks to Data Sync, your field data and guidance lines are wirelessly shared between your machines and managed from Operations Center™ for faster starts in the field.



4 | ENGINE PERFORMANCE

Our 4.5 or 6.8 L John Deere engines boast up to 206 kW (276.8 hp) max power thanks to Intelligent Power Management (IPM) on our tier 3 and final tier 4 models.

5 | PAYLOAD: OFF THE CHARTS

With big payload and a tonne of rear hitch capacity, big loads and the biggest implements are no big deal for the 6M.

6 | STRONG HYDRAULICS

The pressure and flow-compensated hydraulic system, with up to four selective control valves plus Power Beyond, delivers up to 195 l/min for top productivity.

10 | AXLES AND TYRES

Take your pick from a broad portfolio of axles and tyre options, including flange and rack-and-pinion axles.

11 | 100% JOHN DEERE

And 100% backed by us, engines, cab, transmissions, and full-frame chassis are all designed, manufactured and tested by John Deere.

12 | LOW COST OF OWNERSHIP

Low fuel consumption, low maintenance and repair costs, and a solid resale value guarantee you the best value for your money.



**SHORT FRAME:
COMPACT BUILD,
AGILE PERFORMANCE**

**SMALL FRAME:
THE ALL-ROUNDERS**

**MID FRAME:
SOLID POWER**

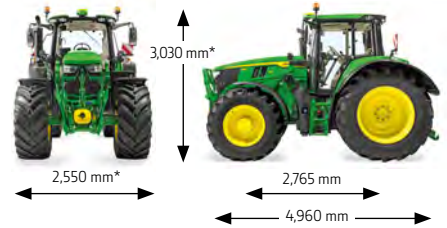
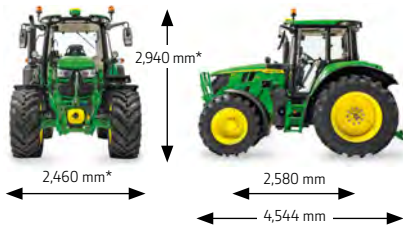
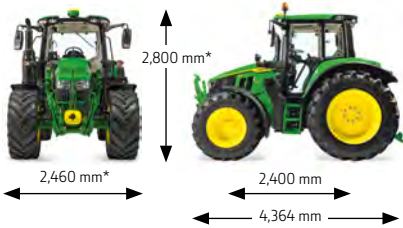

5,900 KG**

6,200 KG**

7,800 KG**

ENGINE PERFORMANCE

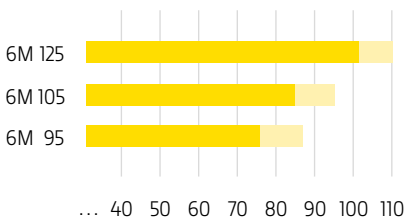

ENGINE PERFORMANCE

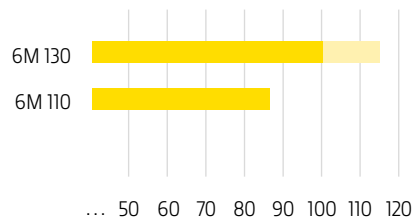

ENGINE PERFORMANCE

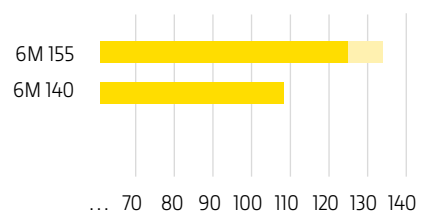

* Width and height will vary based on tyre and axle configuration
 ** Shipping weight (measured with average specifications)



**LARGE FRAME:
THE POWER TO PERFORM**

**XTRA LARGE FRAME:
HEAVY-DUTY PERFORMERS**

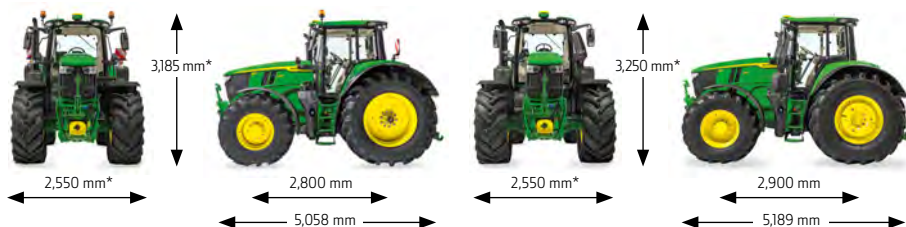

8,500 KG**

9,300 KG**

ENGINE PERFORMANCE

ENGINE PERFORMANCE

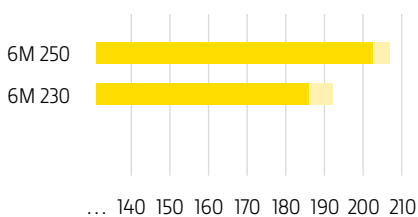
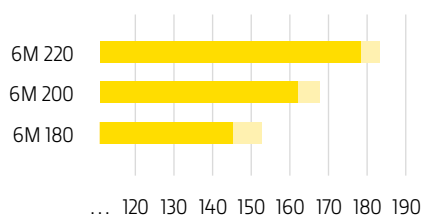

■ Max. power (ECE-R120), kW
 ■ Max. power with IPM (ECE-R120), kW



6M SHORT FRAME TRACTORS

COMPACT BUILD, AGILE PERFORMANCE

Their short wheelbase and compact build predestine these models for front loader work even in the tightest spaces. With an impressive payload, they won't break a sweat with heavy implements and with a top speed of 50 km/h, the 6M gets you to where you need to be fast.

ENGINES

	6M 95	6M 105	6M 125
Cylinders	4	4	4
Displacement (l)	4.5	4.5	4.5
Max. power (ECE-R120), kW (hp)	77 (103)	85 (114)	101 (136)
Max. power with IPM (ECE-R120), kW (hp)	88 (118)	96 (128)	110 (147)

MOVE FASTER

You'll get things done faster by choosing one of our 50 km/h transmissions.



* Front Tyre Size (420/70 R24)

WORK ANYWHERE

Even with the loader mounting frames and loader connected, the 6M short frame tractors maintain a surprisingly small turning radius of 4.35 m. Perfect for front loader work in even the tightest of spaces.

HOOK UP ANYTHING

Built to handle the heaviest of implements, the super-robust rear hitch of the 6M small frame tractors has a maximum lift capacity of up to 5,700 kg.



SEE EVERYTHING

The dropped hood raises front visibility to bring the action closer to you. The first spot visible in front of you is just 6.5 m ahead.

6M SMALL FRAME TRACTORS

THE ALL-ROUNDERS

The power to pull more in the field and handle bigger implements, agile enough for loader work, and faster on the road—experience the versatility of this high-horsepower 4-cylinder compact tractor.



ENGINES

	6M 110 TIER 2	6M 130
Cylinders	4	4
Displacement (l)	4.5	4.5
Max. power (ECE-R120), kW (hp)	86 (115)	105 (141)
Max. power with IPM (ECE-R120), kW (hp)	N/A	115 (154)



AT HOME ON THE ROAD

Powerful engines featuring an extra 20 hp boost in a lightweight, compact format make these tractors natural transport application performers.



A TRUE ALL-ROUNDER

The 4.5 L engine in the 6M 130 delivers up to a very solid 115 kW (154 hp) Max with Intelligent Power Management. The 6M 130 is ready for any job.

AGILE LOADERS

With a 2,580 mm wheelbase for top manoeuvrability, the rugged John Deere full frame design and powerful PFC hydraulics (optional), our small frame models boast excellent agility for efficient front loader performance.



6M MID FRAME TRACTORS

SOLID POWER

These 6-cylinder models deliver a solid and comfortable ride in the field and on the road, with an ideal blend of agility, power and durability that makes them robust and reliable performers in heavier fieldwork.



ENGINES

	6M140 TIER 2	6M155
Cylinders	6	6
Displacement (l)	6.8	6.8
Max. power (ECE-R120), kW (hp)	109 (146)	125 (168)
Max. power with IPM (ECE-R120), kW (hp)	N/A	134 (179)



ALL MUSCLE

All 6M mid frame models come with our proven 6-cylinder, 6.8 L PowerTech™ engine with plenty of power and torque reserves, making sure you are ready for anything.



CONVENIENT SCV CONTROL

Optionally available with 3 electronic SCVs, controlled with ergonomic convenience from the compact CommandARM™ or the Right Hand Console. Not quite enough? You can take that up to 4 SCVs + 3 Mid SCVs if your applications require it.



TRUE TRANSPORT PERFORMERS

In our 6M 155, you will command up to 134 kW (179 hp) max. with IPM in a lightweight, 7.8-tonne mid frame envelope with great fuel efficiency in transport. Moreover, get any job done faster with the optional 50 kph transmission.

6M LARGE FRAME TRACTORS

THE POWER TO PERFORM

When your jobs are big, numerous and tough, these are your tractors. As an arable farmer, you will love their 2,800 mm wheelbase and oversized tyres that bring all power to the ground with maximum efficiency. Performance-oriented contractors also favour these tractors for their top on-road performance.



ENGINES

	6M 180	6M 200	6M 220
Cylinders	6	6	6
Displacement (l)	6.8	6.8	6.8
Max. power (ECE-R120), kW (hp)	146 (195)	162 (217)	178 (239)
Max. power with IPM (ECE-R120), kW (hp)	153 (205)	168 (226)	184 (246)

6M XTRA LARGE FRAME TRACTORS

HEAVY-DUTY PERFORMERS

With stellar on-road performance and a rock-solid, comfortable ride even in heavy-duty applications thanks to its 100 mm longer wheelbase and 2.05 m tyres, the 6M Xtra Large Frame models give you powerful and efficient versatility.



ENGINES

	6M 230	6M 250
Cylinders	6	6
Displacement (l)	6.8	6.8
Max. power (ECE-R120), kW (hp)	186 (250)	202 (271)
Max. power with IPM (ECE-R120), kW (hp)	191 (256)	206 (277)

TRUE POWER

With up to 195 l/min hydraulic pump and PTO options like the 540E/1000/1000E, 6M Xtra Large Frame models give you the powerful versatility to meet even the most challenging implement demands.

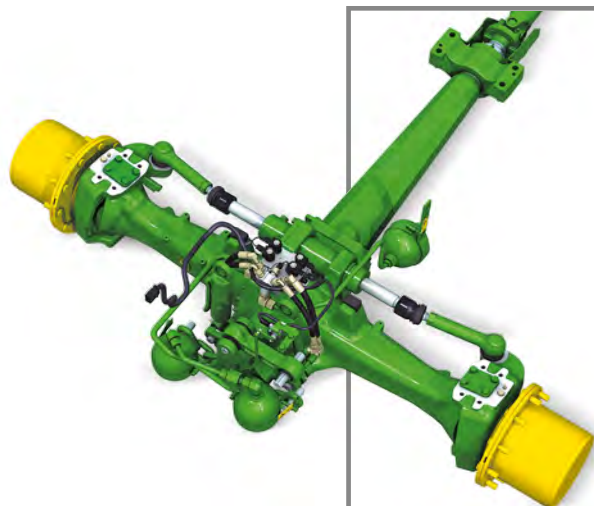

RIDE IN COMFORT

The optional TLS™ suspension is a fully integrated, self-levelling front suspension to increase both transport and field productivity with superior stability, ride and comfort.





In the 6M's productivity cab everything is optimised for making the most of your time there.

THE SEE MORE, DO MORE CAB

When we designed this tractor cab, our purpose was simple: to help you do more, with more ease. Your 6M workspace is all about intuitive and straightforward tractor operation. Guided by best-practice ergonomic principles, the design of the 6M's right-hand console and the compact CommandARM™ is perfectly aligned with the Corner Post Display in A-post—it's a smoothly productive operator experience that is enclosed by more glass all around for a wide-open unencumbered view.



PANORAMA ROOF

When you've got some weight on your loader, you need to be in full visual control of the situation. The sweeping views of the optional panorama roof allow you to be more precise and quicker in all your front loader tasks.



COMFORT WITHOUT COMPLEXITY

CAB COMFORT

You're going to spend many hours in your 6M cab. So, we made it as comfortable, convenient and straightforward as possible. Get in, get going.



1 | CORNER POST DISPLAY

Featuring user-friendly graphics and precise digital gauges, the dashboard gives you a well-organised overview of all major systems.

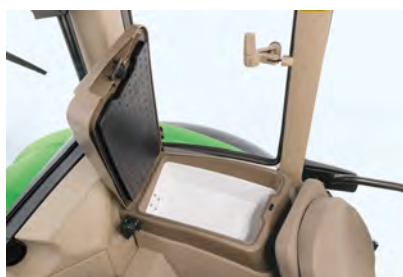

2 | NEAT AND TIDY STORAGE

If you like your cab uncluttered but still have items you need to bring along, this is where you can keep them conveniently accessible. Alternatively, there's a fridge that fits the space.



3 | SIT WELL

No matter how long your day in the cab is, our seats feature adjustments and suspension characteristics to ensure you're comfortable and protected.

INTUITIVE CONTROL

CONTROLS

The combination of the Corner Post Display with either the right-hand console or the compact CommandARM provides an entirely intuitive interface to your 6M, with effortless fingertip control and easy monitoring of all tractor functions.



COMPACT COMMANDARM™

Better controls give you more control: Operate all transmission functions at the highest level of comfort, control AutoTrac™, set engine speed with precision and control the rear hitch.



RIGHT HAND CONSOLE

You've got all the basics covered with this one—it's ergonomically designed, with all of the most essential controls within easy reach for you.



G5™ AND G5 PLUS UNIVERSAL

The optional 10.1" G5 Universal features a faster processor for shorter boot-up times, displays information in extra crisp high definition, and delivers seamless documentation. As our largest screen ever, the 12.8" G5 Plus Universal offers a lot more space to show a full overview of your machine and implement settings at a glance. It is available as an option for most 6M models.

CORNER POST DISPLAY

Located on A-post, in direct line of sight, the Corner Post Display shows important messages and warnings about essential tractor functions. It's conveniently operated by the combination of a selection wheel and quick access keys on the right-hand console.



Front axle suspension—auto mode and max mode conveniently integrated



Configure work light settings



Hitch menu—Load depth, upper limit, drop rate



Transmission menu—Eco engine speed, reverser ratio



Hydraulics menu—hydraulic flow control



Drop PTO on—Drop to target—PTO engaged



Performance monitor—measure performance, hectare count

iTEC™

iTEC Basic menu—iTEC on/off, and choose functionality



Maintenance menu—Check/control service interval + diagnostics

ELECTRONIC JOYSTICK

Ergonomically positioned on the compact CommandARM or on the armrest, the electronic joystick works great for loader applications or can also be reconfigured for operating three eSCV's, rear hitch or one ISOBUS AUX functionality.





LIGHT UP THE NIGHT

VISIBILITY

Stay productive 24/7 with the bright 360° visibility from lighting packages with up to 12 cab lights.

Work lights are cleverly integrated into the front, rear and sides of the roofline to prevent damage from low branches.



Our factory-installed lighting packages deliver a wide, bright and concentrated field of light all around your 6M. For even more demanding lighting requirements you'll want to opt for our LED lighting packages which consume less power, provide an even brighter, daylight-quality light and last longer.

SELECT LIGHT PACKAGE

- 1 | Four front grill mounted halogen lights (6M 95 – 6M 125)
Six front grill mounted halogen lights (6M 130 – 6M 250)
- 2 | Eight cab roof mounted halogen lights
- 3 | Two belt line mounted turn lights
- 5 | Two fender mounted brake and turn lights

OPTIONAL

- 6 | Footsteps lights on both sides
- 7 | Two belt line work lights (HB3 or LED)
- 8 | Two belt line road lights (H4)
- 9 | Single or dual beacon lights

SELECT+ LIGHT PACKAGE

- 1 | Four front grill mounted halogen lights (6M 95 – 6M 125)
Six front grill mounted halogen lights (6M 130 – 6M 250)
- 2 | Ten cab roof mounted halogen lights
- 3 | Two belt line mounted turn lights
- 5 | Two fender mounted brake and turn lights
- 6 | Footstep lights on both sides

OPTIONAL

- 7 | Two belt line work lights (HB3 or LED)
- 8 | Two belt line road lights (H4)
- 9 | Single or dual beacon lights

PREMIUM LIGHT PACKAGE

- 1 | Four front grill mounted LED lights (6M 95 – 6M 125)
Six front grill mounted LED lights (6M 130 – 6M 250)
- 2 | Ten cab roof mounted LED lights
- 3 | Two belt line mounted turn lights
- 4 | LED Low Beam Lights
- 5 | Two fender mounted brake and turn lights
- 6 | Footsteps lights on both sides

OPTIONAL

- 7 | Two belt line work lights (HB3 or LED)
- 8 | Two belt line road lights (H4)
- 9 | Single or dual beacon lights



PRECISION AG ON DEMAND

MAKE THE MOST OF YOUR DAY

More than just a tractor, with the optional StarFire™ Universal receiver, the optional G5 or G5^{Plus} Universal Display, and the included JDLink™ connectivity, you can make sure your 6M has everything on board for your quick and effortless start into precision agriculture. Experience the convenience of seamless documentation and data management in the free-of-charge John Deere Operations Center, and you are 100% equipped to step into the future of farming.

G5™ AND G5^{PLUS} UNIVERSAL

Information has never looked this beautiful. On their massive 10.1" or 12.8" touchscreen displays, the G5 and G5^{Plus} Universal Displays include AutoTrac, Section Control, allowing individual control of up to 255 sections, and Variable Rate Control.

You'll also benefit from full AEF ISOBUS compatibility, JDLink Connectivity, Documentation and Data Sync as standard features, along with the familiar, user-friendly interface of Generation 4 Displays, so you can immediately boost your performance without having to learn anything new.





FULL AEF ISOBUS COMPATIBILITY

SECTION CONTROL (UP TO 255 SECTIONS)

DATA SYNC

DOCUMENTATION

WORK PLANNER

VARIABLE RATE CONTROL

AUTOTRAC™

FREE-OF-CHARGE OPERATIONS CENTER™

JDLINK™ CONNECTIVITY



STARFIRE™ UNIVERSAL RECEIVER

We've just made it easier and more attractive for you to work with more precision in everything you do. Thanks to the ability of StarFire 7500 Receiver to communicate with GPS, GLONASS, and the GALILEO and BEIDOU satellite constellations, you'll enjoy superior signal stability in shaded areas at any signal accuracy level. For an even faster start in the field, you can wirelessly share the guidance lines between your machines and manage them centrally in a powerful farm management tool: the John Deere Operations Center.



**5 YEARS OF
REPEATABILITY**

**73% FASTER
PULL-IN TIME***

**17% MORE ACCURACY
WITH SF-RTK***

COST-EFFECTIVE STARFIRE™ RTK

You can also get the SF-RTK signal option with 1 year or permanent licence. This gives you an RTK accuracy of +/-2.5 cm with 5-year repeatability of guidance lines and boundaries for precision applications without having to invest in additional hardware.

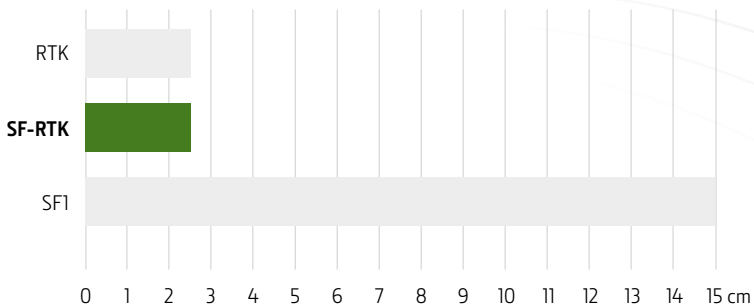

JOHN DEERE OPERATIONS CENTER™ FREE OF CHARGE

The John Deere Operations Center is the central platform for connecting your machines, operators, and fields. Plan your work and send all job information directly to individual machines to eliminate in-field setup delays and mistakes. You can also create prescription maps with affiliated software partners and easily import data. In addition, dealer specialists are available to support you in enhancing your farming sustainability and profitability.



GET JOHN DEERE OPERATIONS CENTER NOW, FOR FREE



Apple



Google Play



BOOST YOUR YIELD

SITE-SPECIFIC FARMING

Put the right seed in the right place at the right depth for successful germination. Then apply exactly the right amount of care. John Deere Precision Ag Technology is your ticket to the benefits of site-specific farming.

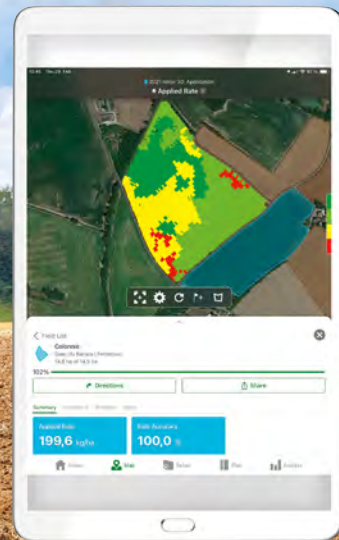

SECTION CONTROL

Reduce overlap and minimise skips to ensure precise crop protectant and nutrient application with Section Control—for up to 255 sections on your implement.



VARIABLE RATE CONTROL

Optimise your profits with variable rate application. Increase fertiliser, seeding, and chemical efficiency while boosting yield and reducing costs. Standard with all G5 Displays.



PLANT/SEED

In your business, every seed counts. With a 6M, you can customise seeding rates for different zones in the field based on a prescription map to boost yield and lower input costs.



NURTURE

Optimising your yields while managing fertiliser costs has never been easier. Use the 6M's Precision Ag capabilities like Variable Rate and Section Control to apply the right amount of fertiliser at the exact right spot in the field based on a prescription map.



SPRAY BETTER

Every drop goes where it matters most when you're on a 6M tractor with a John Deere Sprayer. Achieve the highest spraying accuracy on every pass, thanks to our unique PowrSpray™ and Individual Nozzle Control technology.



KNOW MORE, GROW MORE

Make better decisions based on better information from the John Deere Operations Center: Powerful management tools let you monitor your machines' productivity and analyse your crops' performance. Supported by dealer specialists, you will improve your farming sustainability and profitability.

POWER WITHOUT LIMITS

ENGINES

Get all the power you need with less fuel and lower emissions from our PowerTech™ 4.5 L 4 cyl. or 6.8 L 6 cyl. engines. The 6 cyl. engines feature extended drain intervals of up to 750 hours.*

SOLID POWER

Compact goes beyond. Whatever the job, the 4.5 L EWS engine in the 6M 95, 6M 105 and 6M 125 models will deliver more than enough power thanks to 40% torque reserve and Intelligent Power Management.

The 2-stage turbocharging system in the 4.5 L engine in the 6M 130 boosts power to achieve up to 115 kW (154 hp) (max with IPM).



4.5 L engine



COOL EFFICIENCY

Benefit from lower power consumption with a reversible fan that keeps the hood intake panel free from debris.

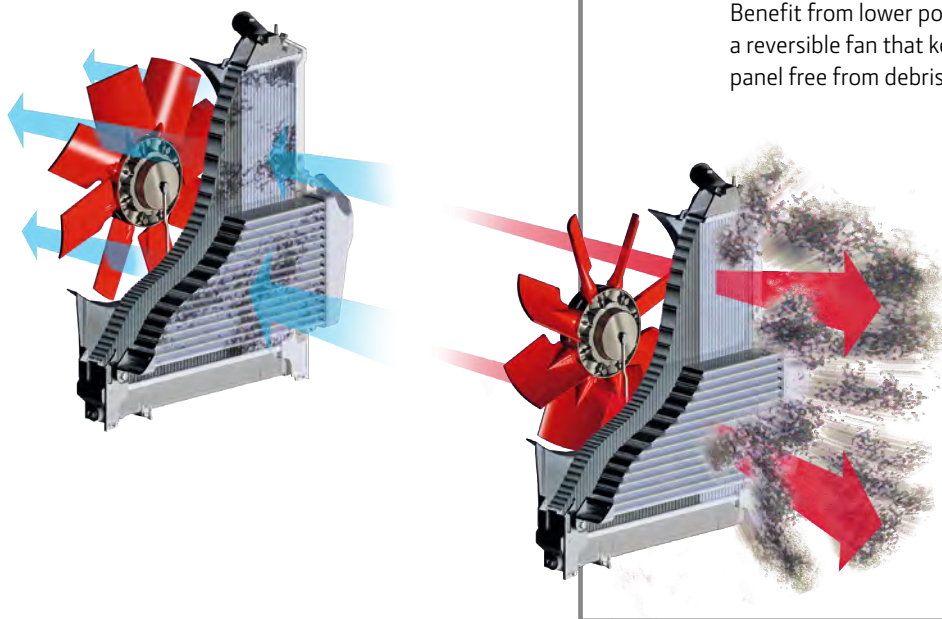

PROVEN TECHNOLOGY

The higher power output of our 6-cyl. engines comes from refined High Pressure Common Rail technology with injection pressure of up to 2,500 bar. The engine in the 6M 155–6M 220 models has a Variable Geometry Turbocharger that boosts performance and efficiency across the torque curve, while the engine in the 6M 230 and 6M 250 uses a 2-stage turbocharging system in which the variable geometry turbocharger multiplies the pressure created by a fixed vane turbocharger.



6.8 L PSS engine



**LONG 750 H OIL
CHANGE INTERVAL***

YOU'RE IN FULL CONTROL

POWRQUAD™ PLUS, AUTOQUAD™ PLUS
AND COMMANDQUAD™ PLUS

Our proven transmission portfolio combines superior ease of operation and convenience with outstanding efficiency to complement the power and torque of your 6M. For the 6M 95–6M 155 models a creeper option with speeds as low as 72 m/h at 1,000 rpm is available.

AUTOQUAD PLUS

Super convenient: **Speed Matching** will automatically select the right gear to match engine speed and ground speed for a smoother ride and less transmission wear, while the **declutch** function allows you to conveniently shift ranges without using the clutch pedal. Other available options include fuel and emission-saving **EcoShift** and a 50 km/h version if moving fast is high on your priority list.

**ECOSHIFT
AVAILABLE**



POWRQUAD PLUS

Three versions are available: 16/16, 20/20 and 24/24. All provide rapid shifting including speed matching for smooth shifting between ranges. They are operated by a single range lever and push-button gear selection. SoftShift technology keeps the changes smooth, even under load.



COMMANDQUAD PLUS

Looking for that extra level of operational ease? Say hello to a lot less clutching and experience less tiresome, more productive days in the cab. You'll love the enhanced automatic capabilities of CommandQuad Plus.

FULL AUTO MODE

Seamless driving that combines automatic shifting with fuel savings at a high level of convenience.

STOP-AND-GO EASE

The AutoClutch function lets you stop the tractor without pressing the clutch—it makes a huge difference if you do a lot of stop-and-go work.

EFFICIENT MULTI-RANGE SHIFTING

Fully robotised gear and range shifting: no clutching required. Using the double-bump feature, you can shift up one range with a quick double bump (C1 to D1 for example).

ECOSHIFT AVAILABLE

With a transport speed of 40 km/h, this version fully automatically operates at engine speeds of only 1,670 rpm.

- 1 | Speed wheel
- 2 | Shift lever
- 3 | Automatic mode
- 4 | Manual mode
- 5 | Range selection



INFINITE SPEED ADJUSTMENT

AUTOPOWR™

AutoPowr is a hydro-mechanical transmission that delivers stepless and continuous power at speeds between 30 m/h and 50 km/h.

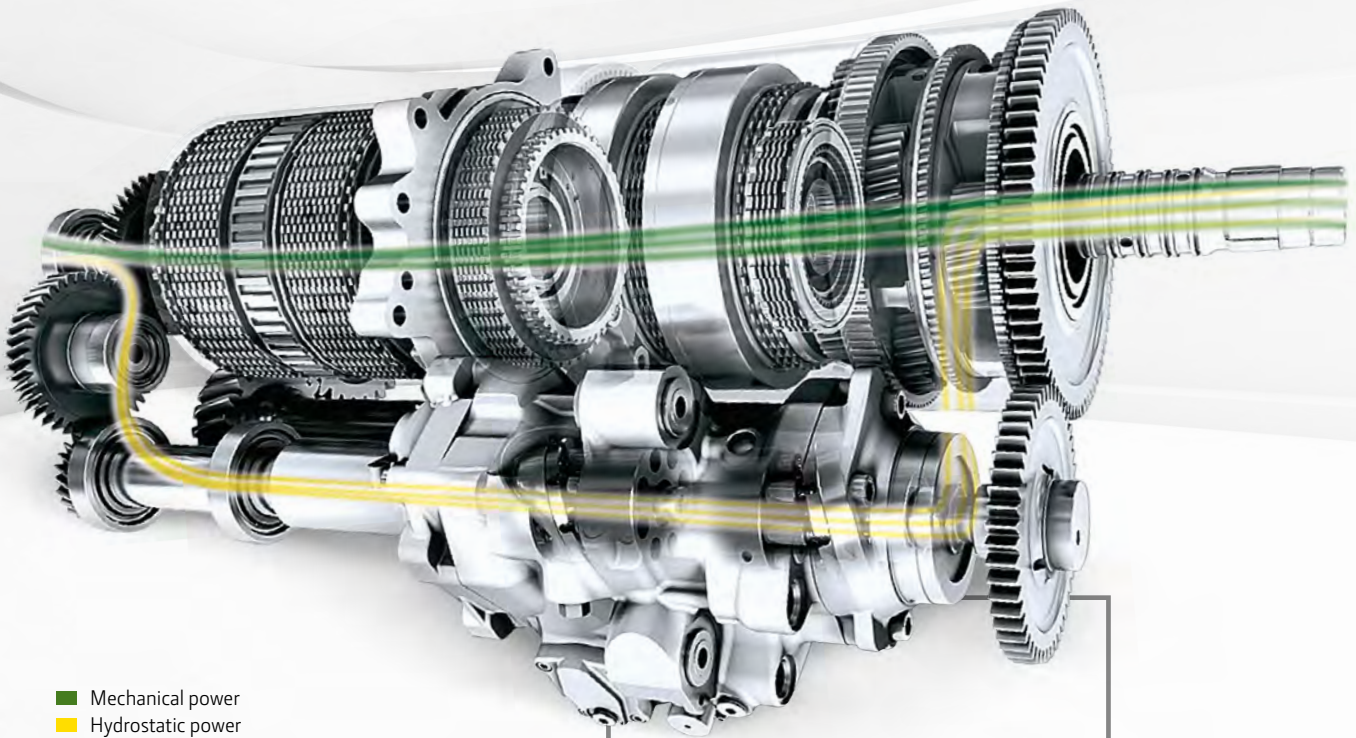

■ Mechanical power
■ Hydrostatic power

**FINALLY, ULTIMATE
CONVENIENCE ALSO
MEANS SUPERIOR
EFFICIENCY**

COMFORT

AutoPowr maintains the selected speed by automatically responding to changing load conditions.

FUEL ECONOMY

Once running at maximum road speed, engine rpm automatically drops to the minimum level required to maintain that speed—reducing noise and saving fuel. 50 km/h is maintained at 1,630 rpm, 40 km/h at 1,300 rpm.



AutoPowr on the right-hand console with mechanical SCVs



AutoPowr on the right-hand console with electrical SCVs



AutoPowr on the CommandARM

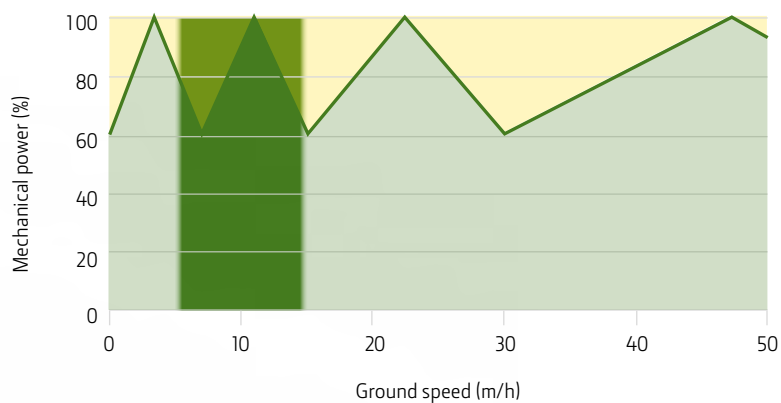

EFFICIENCY

AutoPowr delivers 100% mechanical power at the following working speeds: 3.5 km/h (heavy draft), 11 km/h (light draft), 22.5 km/h (heavy transport) and 47.2 km/h (light transport). This results in superb transmission efficiency, close to that of mechanical transmissions. In fact, AutoPowr is always using more than 60% of the available mechanical power.



The John Deere full frame design provides a robust platform that effectively absorbs and resists loads and shocks—you're guaranteed a smooth and comfortable ride when you're on the road.

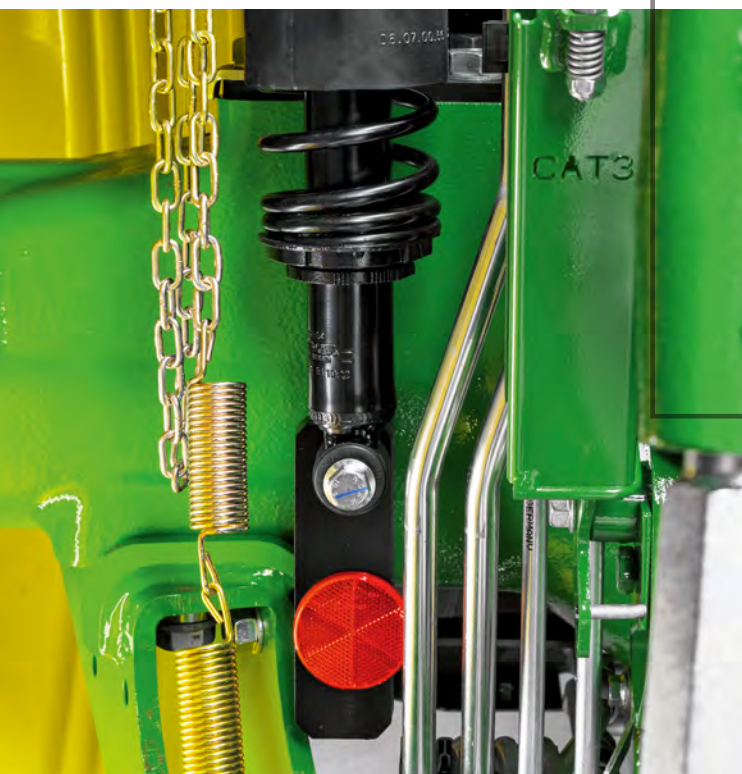

MECHANICAL CAB SUSPENSION

Say good-bye to irritating vibrations and drive all day with relaxed focus. Our maintenance-free mechanical cab suspension pays for itself with increased driver productivity and best-in-class comfort.



COMFORT THAT KEEPS YOU SHARP

RIDE COMFORT

A long day in the cab is hard work. Shocks and vibration cause fatigue. Proper suspension alleviates these effects and helps keep operators alert.

The John Deere full frame design is a solid platform that absorbs, and resists loads and shocks from the wheels, heavy implements and front loaders. To further minimise the fatigue and stress caused by unpleasant vibrations, 6M tractors can be specified with optional mechanical cab suspension. The standard front axle delivers superior on-road handling—Triple Link Suspension (TLS) is optionally available.

TRIPLE LINK SUSPENSION™

TLS—one short acronym with lots of benefits.

- 7% more power to the ground than with a rigid axle
- A long draft member for better draft performance
- Hitch sensing system synchronisation to compensate power hop effects under heavy pull
- Self-levelling with 100 mm suspension travel
- Automatic axle sensitivity and suspension rate adjustment
- Optional brake discs in front axle hubs for more braking capacity



SMART MUSCLE ON TAP

HYDRAULICS AND PTO

There's plenty of power to go around with the pressure-compensated or pressure-and-flow-compensated hydraulic systems.

EFFICIENT FLOW CONTROL

Easily controlled via the Corner Post Display, the 6M's Pressure and Flow Compensated system (PFC) will produce a powerful flow of up to 195 l/min. The smart part comes in when flow is not needed: The system automatically enters a "no flow" standby mode—improving fuel efficiency, implement performance, and steering response. For operations with less demanding tasks, a cost-effective, more basic Pressure Compensated system (PC) with 80 l/min is also available.

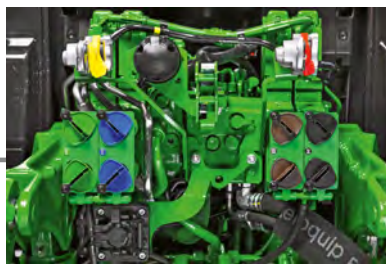

EASY SCV ACCESS

Conveniently located between the rear hitch rails, the SCV stack groups together up to 4 SCVs or 4 SCVs plus Power Beyond, and the Pressure-Free Return circuit valve, with hydraulic flow easily adjusted from the Corner Post Display.





Adjustable Load Sensing: up to +24 bars for efficiently running implements that require high oil flow.

HYDRAULIC PUMPS

With pressure-and-flow-compensated (PFC) systems, the hydraulic pumps on the larger 6M models deliver up to 195 l/min of flow, while the optional pressure-compensated (PC) systems on the 6M 95–6M 130 tractors go up to 80 L/min.

	6M 95 – 6M 130	6M 110	6M 140	6M 155 – 6M 220	6M 230, 6M 250
PC 80 l/min	□	□			
PFC 114 l/min	■	■	■	■	
PFC 155 l/min				□	■
PFC 195 l/min					□

■ base □ optional

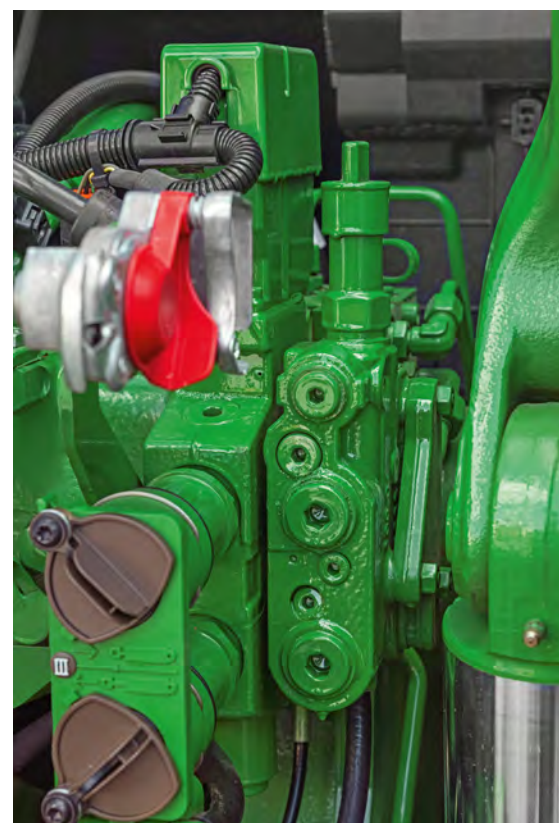

ALL TERRAIN, EVERY APPLICATION

AXLES

Depending on the tread adjustment requirements of the jobs you primarily work with your tractor, you can choose between flange or rack-and-pinion axles on your 6M.



FLANGE AXLES

Fixed or adjustable wheels: Available for all 6M models, these rear axle solutions give you various width settings. If that works for what you do, these axles are a great alternative to the more versatile rack-and-pinion axles.



79 mm x 2,286 mm
79 mm shaft—short version

Available for:
6M 95, 6M 105, 6M 110,
6M 125, 6M 130

RACK-AND-PINION AXLES

Cast wheels and the rack-and-pinion design have a couple of advantages: The heavier design provides additional weight and makes tread adjustments quick and easy. If many of your jobs require different tread settings, you'll be well served with our two-position steel wheels with rack-and-pinion axles.



92 mm x 2,806 mm
92 mm shaft

Available for:
6M 155



In combination with the large frame models' long wheelbase, the 6M's bigger tyres reduce slippage for less compaction and help get power to the ground more efficiently.

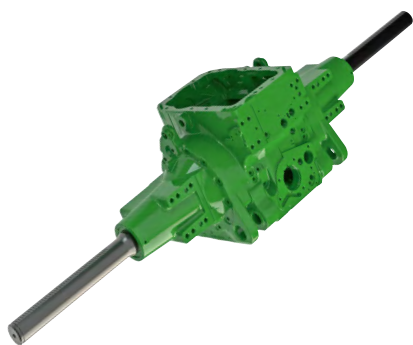

79 mm x 2,550 mm
79 mm shaft

Available for:
6M 95, 6M 105, 6M 110,
6M 125, 6M 130

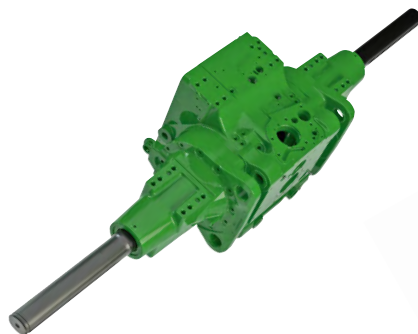

86 mm x 2,438 mm
86 mm shaft

Available for:
6M 95, 6M 105, 6M 125,
6M 130, 6M 140



92 mm x 2,550 mm
92 mm shaft

Available for:
6M 155, 6M 165, 6M 180,
6M 200, 6M 220



100 mm x 2,550 mm
100 mm shaft

Available for:
6M 180, 6M 200, 6M 220,
6M 230, 6M 250



100 mm x 2,806 mm
100 mm shaft

Available for:
6M 180, 6M 200, 6M 220



100 mm x 3,009 mm
100 mm shaft

Available for:
6M 180, 6M 200, 6M 220,
6M 230, 6M 250

LIFT IT ALL

FRONT LOADERS

In designing the 6M, we focused intently on the demands of front loader tasks: manoeuvring to the load, seeing what you're doing, and delivering the power you need.

The combination of a short 2,400 mm wheelbase, reduced overall length and a nimble turning radius of 4.35 m is guaranteed to get your 6M right where you need it to be.

On certain terrains, front loader work can be a tricky balancing act. Not in a 6M. Its super-strong integrated full frame and low centre of gravity give you the rock-solid foundation from which to master even the most challenging front loader jobs.

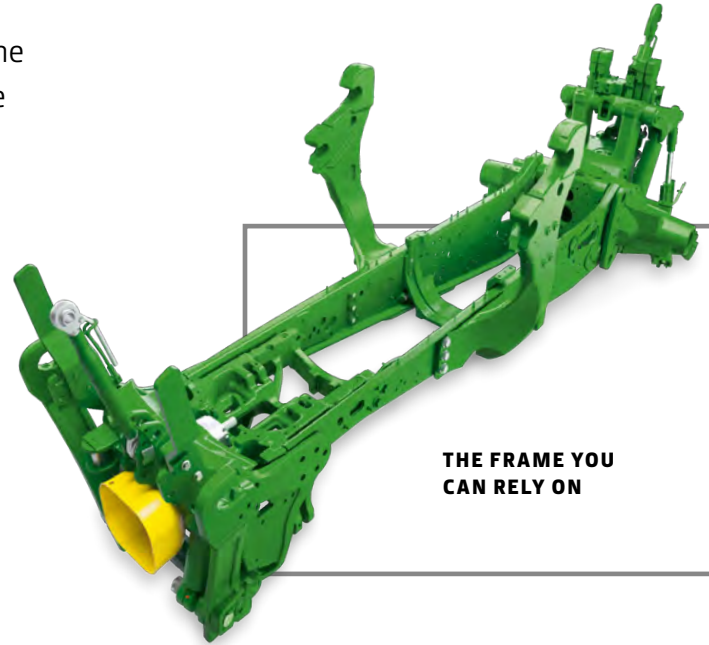

**THE FRAME YOU
CAN RELY ON**



A FULLER VISION

Working in a 6M cab feels like blinders have been taken off of you: the panorama roof, the sweeping windshield, and the low hood open up your field of vision like never before.



BORN TO LIFT

The 6M gives you a lot of power to work with. Its advanced Pressure and Flow Compensated (PFC) hydraulic system translates into more power and faster cycle times than you'd expect in this tractor class.



6M owners swear by the simple ease of clutchless forward/reverse using the left-hand reverser or the reverser on the joystick.



TIP FOR TONNES

Buttons for gear shifting, reverser (both in orange), up to four hydraulic functions and suspension, are all embedded into the joystick. Both the classic mechanical and the electric joystick in perfect reach move heavy loads with a fingertip.



WHICH LOADER?











LOADER CHOICES

Based on your application, let's narrow down which model is going to work best for you.

The versatile and affordable M loaders are ideal for all standard front loader tasks, such as collecting bales, feeding cattle and moving pallets.

If you need extra lift capacity, perform heavy-duty operations such as forestry and earthwork, or if you're looking for even better visibility, enhanced comfort and performance, our R Series loader will be best for you.



		M LOADER	R LOADER
	Lift capacity		
	Collect bales	✓	✓
	Feed cattle	✓	✓
	Move pallets	✓	✓
	Digging/heavy duty		
	Suspension	□	□
	Lights	-	□

✓ base □ optional - not available

TRACTOR/LOADER COMPATIBILITY

For the perfect fit, you have a choice of two front loader sizes for most 6M models.

	603M/R	623M/R	643M/R	663R	683R
6M 95, 6M 105, 6M 125	■	■	-	-	-
6M 110, 6M 130	-	■	■	-	-
6M 140, 6M 155	-	-	■	■	-
6M 180, 6M 200, 6M 220	-	-	-	■	■
6M 230, 6M 250	-	-	-	-	■



M SERIES LOADERS

LIGHT AND VERSATILE

This is the readily available and affordable all-you-need solution for all standard applications.



TIME SAVING

Connect and disconnect the loader in less than 5 minutes and change implements with just one easily accessible lever.



EASY MAINTENANCE

You can grease all bushings and replace the relevant ones, while hydraulic hoses are protected inside the boom, with easy access to all main hydraulic parts if needed.



A SMOOTHER RIDE

The optional suspension provides an altogether smoother ride for load, tractor and operator.



SEE IT ALL

The design of the M Series is optimised for exceptional visibility when you connect your implements and, of course, during loader operation.

R SERIES LOADERS

RAISE YOUR GAME

Designed for unrestrained productivity and peerless ease of use, these loaders master even the toughest conditions.

Easy to mount, quick to take off—it's the key to higher productivity. John Deere R Series front loaders have our automatic latch designs, making the installation of the loader and implements as easy as click and go and with various self-levelling options available. The John Deere levelling link design makes more power available for lifting and never gets in the way of the operator's view.



UNDERSLUNG LEVELLING LINK

The geometry of our front loader linkage has several advantages. The underslung levelling link does not impair your view, conveys more power and provides easier access for servicing.



CLICK AND GO

Mounting our front loaders could not be quicker or more convenient, thanks to the self-correcting floating system of the built-in automatic mast latch. Separation is just as easy.



AUTOMATIC IMPLEMENT LATCH

The implement is self-guided by centre guides and automatically latched when it reaches the carrier frame.



**MORE LIFT
CAPACITY AND
MORE PRACTICAL
CONVENIENCE TO
GET MORE DONE**

OPTIONAL SOLUTIONS

We have a range of optional solutions that help you access all the built-in benefits of your John Deere R Series front loader. They'll save you time, boost convenience and reduce operator fatigue.



LOADER LIGHTS

Purpose-built John Deere loader lights provide the consistent and reliable illumination you need when working with a front loader in darkness or poor visibility.



LOADER SUSPENSION

Activated from the joystick, its effective damping provides an altogether smoother ride for load, tractor and operator.

POWERGARD PROTECTION PLAN™

STATUS: PROTECTED



POWERGARD PROTECTION PLAN

Base level of protection that covers unusual events that can lead to costly repairs, and also covers the main drivetrain components.

PowerGard agreements protect you against unexpected repair costs and keep your maintenance on track with genuine parts. Two fixed rate packages provide increasingly comprehensive levels of cover to keep your machine running at peak performance with steady uptime.

COMPREHENSIVE (FULL MACHINE)

- Engine
- Electrical
- Powertrain
- Steering and brakes
- Hydraulics
- Frames, axles and bearings
- Operator's station

LIMITED

- Engine
- Powertrain

SERVICES THAT BENEFIT YOU

John Deere dealers have access to several cutting-edge digital remote tools that allow them to provide you with a suite of proactive services tailored to your needs.



REMOTE MACHINE MONITORING

It's yet another service that sets John Deere apart. Upon your consent, our Machine Dashboard displays the operating condition data and error codes to your dealer in real time. They can remotely connect to the machine, run further diagnostics and perform remote software updates to help you faster than ever before. Plus, our new Expert Alerts are included as well.

AUTOMATIC MAINTENANCE PLANNING

You'll always be perfectly on track with your maintenance. Automated notifications can be based on actual machine hours or calendar dates and alert you to maintenance tasks which need to be performed.

REMOTE OPERATOR SUPPORT

You need instant advice and can't wait for someone to come to the paddock? Remote Display Access allows your dealer expert to remotely assist you and your operators with machine/implement setup and more—like being virtually in the cab.

EXPERT ALERTS

Expert Alerts, our newest remote diagnostics advancement, is based on smart software algorithms that can predict many potential technical issues before they have a negative impact or cause damage. Repairs become plannable while downtime and costs can be reduced significantly.

EXPERT CHECK

Using a special John Deere inspection checklist, your dealer expert performs a thorough technical examination of your machine. He will advise you on what measures to take and take care of all relevant software updates to ensure maximum uptime in the next season.

OPERATIONS CENTER INTRODUCTION

You want to properly store and manage field boundaries, guidance lines, documentation data and have access to a full suite of farm management tools? Then this is the right package element for you.

OPTIMISATION VISIT

Benefit from dealer product specialist experience to fully exploit your machine's capabilities. Thanks to their detailed product knowledge, dealer product specialists can help you by reviewing your current machine settings and providing improvement recommendations.

All remote services require a JDLink™ telematics module, an active subscription and customer consent. Participating dealers only. Exact services scope depends on individual dealers' offerings.

² At participating dealers only.

SPECIFICATIONS

	SHORT FRAME			SMALL FRAME	
	6M 95	6M 105	6M 125	6M 110	6M 130
	FINAL TIER 4			TIER 2	TIER 3 / FINAL TIER 4
ENGINE PERFORMANCE					
MAX. POWER (ECE-R120), KW (HP)	76.9 (103.1)	85 (114)	101.1 (135.6)	86 (115.3)	105.2 (141.1)
MAX. POWER WITH IPM (ECE-R120), KW (HP)	87.9 (117.9)	95.6 (128.2)	110 (147.5)	N/A	114.7 (153.8)
Rated power (ECE-R120), kW (hp)	69.9 (93.7)	77.2 (103.5)	91.9 (123.2)	80.9 (108.5)	96 (128.7)
Rated power with IPM (ECE-R120) @ 2,100 rpm, kW (hp)	84.6 (113.5)	91.9 (123.2)	106.6 (143)	N/A	110.3 (147.9)
Constant power range rpm	2100 -1550	2100 -1550	2100 -1550	2100 -1600	2100 -1550
Maximum torque, Nm (at 1,600 engine rpm) – without boost	445	492	585	497	609
Manufacturer	John Deere Power Systems				
Aspiration	Single turbocharger with wastegate			Single turbocharger	Dual turbochargers, variable geometry turbo with fixed geometry turbo in series, with EGR
Cylinders / Displacement	4 / 4.5 L			4 / 4.5 L	
REAR PTO					
Type	Electro-hydraulically engaged, oil cooled, multi-disc design				
Option	1977 / 1503 / 1972			1977 / 1503 / 1972	
Option	N/A	N/A	1572 / 1977 / 1663	1572 / 1977 / 1663	
FRONT PTO, OPTIONAL					
Type	Electro-hydraulically engaged, oil cooled, multi-disc design				
Engine speed at rated PTO speed (1,000), rpm	1969				
TRANSMISSIONS					
POWRQUAD™ PLUS					
16F/16R 30 km/h	■	■	■	■	■
16F/16R 30 km/h with Creeper	■	■	■	■	■
16F/16R 38 km/h	■	■	■	■	■
16F/16R 38 km/h with Creeper	■	■	■	■	■
20F/20R 40 km/h	–	–	–	–	–
20F/20R 40 km/h with Creeper	–	–	–	–	–
24F/24R 40 km/h	■	■	■	■	■
24F/24R 40 km/h with Creeper	■	■	■	■	■
AUTOQUAD™ PLUS					
20F/20R 40 km/h	–	–	–	–	–
20F/20R 40 km/h with Creeper	–	–	–	–	–
24F/24R 40 km/h	■	■	■	■	■
24F/24R 40 km/h with Creeper	■	■	■	■	■
20F/20R 50 km/h	–	–	–	–	–
20F/20R 50 km/h with Creeper	–	–	–	–	–
24F/24R 50 km/h	■	■	■	–	■
24F/24R 50 km/h with Creeper	■	■	■	–	■
AUTOQUAD™ PLUS ECOSHIFT					
20F/20R 40 km/h	–	–	–	–	–
20F/20R 40 km/h with Creeper	–	–	–	–	–
24F/24R 40 km/h	■	■	■	■	■
24F/24R 40 km/h with Creeper	■	■	■	■	■
COMMANDQUAD™ PLUS					
20F/20R 40 km/h	–	–	–	–	–
24F/24R 40 km/h	■	■	■	■	■
24F/24R 50 km/h	■	■	■	–	■
COMMANDQUAD™ PLUS ECOSHIFT					
20F/20R 40 km/h	–	–	–	–	–
24F/24R 40 km/h	■	■	■	■	■
AUTOPOWR™					
Infinitely Variable Transmission (IVT™) 40 km/h	■	■	■	–	■
Infinitely Variable Transmission (IVT™) 50 km/h	■	■	■	–	■

MID FRAME		LARGE FRAME			EXTRA LARGE FRAME	
6M 140	6M 155	6M 180	6M 200	6M 220	6M 230	6M 250
TIER 2	TIER 3 / FINAL TIER 4	TIER 3 / FINAL TIER 4			TIER 3 / FINAL TIER 4	
109 (146.2)	125.4 (168.2)	145.6 (195.3)	161.8 (217)	178 (238.7)	186.1 (249.6)	202.3 (271.3)
N/A	133.8 (179.4)	152.9 (205)	168.2 (225.6)	183.5 (246.1)	191.1 (256.3)	206.4 (276.8)
103 (138.1)	114 (152.9)	132.4 (177.6)	147.1 (197.3)	161.8 (217)	169.2 (226.9)	183.9 (246.6)
N/A	128.7 (172.6)	147 (197.1)	161.8 (217)	176.5 (236.7)	183.9 (246.6)	198.6 (266.3)
2100 -1600	2100 -1550	2100 -1550	2100 -1550	2100 -1550	2100 -1550	2100 -1550
632	726	843	936	1025	1077	1171
John Deere Power Systems						
Dual turbochargers, variable geometry turbo with fixed geometry turbo in series, with EGR	Variable geometry turbo charger and cooled exhaust gas recirculation (EGR)	Variable geometry turbo charger and cooled exhaust gas recirculation (EGR)			Dual turbochargers, variable geometry turbo with fixed geometry turbo in series, with EGR	
6 / 6.8 L		6 / 6.8 L			6 / 6.8 L	
Electro-hydraulically engaged, oil cooled, multi-disc design						
1977 / 1503 / 1972	1997 / 1762 / 2010	1960 / 1729 / 1960			1960 / 1729 / 1960	
1572 / 1977 / 1663	1574 / 1979 / 1665	1770 / 1999 / 1765			1770 / 1999 / 1765	
Electro-hydraulically engaged, oil cooled, multi-disc design						
1969			1967			
■	■	-	-	-	-	-
■	■	-	-	-	-	-
-	-	-	-	-	-	-
-	-	-	-	-	-	-
-	■	■	■	■	-	-
-	■	-	-	-	-	-
■	-	-	-	-	-	-
■	-	-	-	-	-	-
-	-	-	-	-	-	-
-	-	-	-	-	-	-
-	■	■	■	■	-	-
-	■	-	-	-	-	-
■	-	-	-	-	-	-
■	-	-	-	-	-	-
-	■	■	■	■	-	-
■	-	-	-	-	-	-
-	-	-	-	-	-	-
-	■	■	■	■	-	-
■	-	-	-	-	-	-
-	-	-	-	-	-	-
-	■	■	■	■	■	■
-	■	■	■	■	■	■

SPECIFICATIONS

	SHORT FRAME			SMALL FRAME	
	6M 95	6M 105	6M 125	6M 110	6M 130
AXLES					
Suspended front axle (option)	Standard: MFWD Optional: Triple Link Suspension (TLS) MFWD Axle (hydro-pneumatic, permanently active, triple link, self-levelling suspension) Optional: Triple Link Suspension MFWD with Brakes				
Suspension range with TLS™	100 mm suspension range				
Engagement front differential lock	Self-locking differential				
Engagement rear differential lock	Electro-hydraulic with oil cooled clutch				
Final drive type	Three planetary gear reduction				
Rear axle	Flange axle or Rack and Pinion axle				
STEERING					
Type	Dynamic load sensing, hydrostatic, flow metering				
HYDRAULIC SYSTEM					
Type	Pressure compensated (PC) or Pressure-and-flow compensated (PFC) system with Load Sensing function				
Flow at rated engine speed base / option, l/min	114 / 80				
Selective control valves	Up to 4 rear + 3mid				
Power beyond	Optional				
3-POINT HITCH—REAR					
Type	Electronic lower link				
Maximum lift capacity at coupling point, kg (base/option)	4,350 / 5,650			5,700 / 6,400	
Lift capacity through full lift range (OECD 610 mm), kg (base/option)	2,750 / 3,600			3,600 / 4,100	
3-POINT HITCH—FRONT, OPTIONAL					
Type	Front hitch controlled by 1st rear SCV				
Maximum lift capacity at hooks, kg	4,400				
Lift capacity through full lift range (OECD at the hooks), kg	3,300				
CAB					
Suspension (option)	Mechanical cab suspension (MCS)				
Noise level at operator's ear, dB(A)	86				
Display	Corner post display located at A-post				
MISCELLANEOUS					
AutoTrac™ Ready	Optional				
ISOBUS ready	Optional				
ISOBUS implement connection	Optional				
Immobilizer	Optional				
Trailer brake systems (options)	Hydraulic and / or pneumatic system				
Pneumatic trailer brake system (option)	2 line system, park brake actuation engages trailer brakes, comes with air dryer				
CAPACITIES					
Fuel Tank (base/option), l	175 / 200			260	205 / 225 / 260
DEF tank, l	19			N/A	14
Engine coolant, l	20			22	
DIMENSIONS AND WEIGHTS					
Wheelbase, mm	2,400			2,580	
Shipping weight, kg	5,900			6,200	
Maximum permissible gross weight, kg	10,450			10,450	

MID FRAME		LARGE FRAME			EXTRA LARGE FRAME	
6M 140	6M 155	6M 180	6M 200	6M 220	6M 230	6M 250
Standard: MFWD						
Optional: Triple Link Suspension (TLS) MFWD Axle (hydro-pneumatic, permanently active, triple link, self-levelling suspension)						
Optional: Triple Link Suspension MFWD with Brakes						
100 mm suspension range						
Self-locking differential		Standard: Self-locking differential				
Electro-hydraulic with oil cooled clutch						
Three planetary gear reduction					-	
Flange axle or Rack and Pinion axle						
Dynamic load sensing, hydrostatic, flow metering						
Pressure & Flow Compensated (PFC) System with Load Sensing function						
114	114 / 155	114 / 155			155 / 195	
Up to 4 rear + 3 mid						
Optional						
Electronic lower link						
5,700 / 6,400	6,800 / 7,650	8,050 / 9,050			8,800 / 9,900	
3,600 / 4,100	3,500 / 3,950	4,600 / 5,150			5,900 / 6,700	
Front hitch controlled by 1st rear SCV						
4,400						
3,300					4,400	
Mechanical cab suspension (MCS)						
86						
Corner post display located at A-post						
Optional						
Optional						
Optional						
Optional						
Hydraulic and / or pneumatic system						
2 line system, park brake actuation engages trailer brakes, comes with air dryer						
325	285 / 330	325 / 425			410 / 470	
N/A	16	20			25	
27.4		28			34	
2,765		2,800			2,900	
7,800		8,500			9,300	
12,400		13,450			15,000	

SPECIFICATIONS

	SHORT FRAME			SMALL FRAME	
	6M 95	6M 105	6M 125	6M 110	6M 130
CAPACITIES					
Fuel Tank (base/option), l		175 / 200		260	205 / 225
DEF tank, l		19		N/A	14
Engine coolant, l		20		22	
DIMENSIONS AND WEIGHTS					
Wheelbase, mm		2,400		2,580	
Shipping weight, kg		5,900		6,200	
Maximum permissible gross weight, kg			10,450		
TYRE SIZES					
Front tyre sizes, max. available (SRI)		520 / 60R28 (SRI 650)		600 / 60R28 (SRI 675)	
Rear tyre sizes, max. available (SRI)		(SRI) 650 / 60R38 (SRI 825)		710 / 60R38 (SRI 875)	

LOADER SPECIFICATIONS

SHORT FRAME 6M				6M 95 / 6M 105 / 6M 125	
LOADER MODEL				603M	
LEVELLING SYSTEM				MSL	
Front tyre				540/65R24	
Rear tyre				600/65R38	
LOADER					
Bucket				1,850 Standard	
Bucket Weight				kg	216
Lift capacity @ full height	Measured @ 800 mm ahead of pivot	(V)	kg	1,703	
Maximum lift height		(A)	mm	3,937	
Reach	@ Maximum height	(D)	mm	813	
Cycle times	Loader raise		sec	4	



MID FRAME		LARGE FRAME			EXTRA LARGE FRAME	
6M 140	6M 155	6M 180	6M 200	6M 220	6M 230	6M 250
325	285 / 330		325 / 425			410 / 470
	16		20			25
	27.4		28			34
	2765		2800			2900
	7,800		8,500			9,300
	12,400*		13,450			
	600 / 60R28 (SRI 675)		600 / 70R28 (SRI 725)			600 / 70R30 (SRI 750)
	710 / 60R38 (SRI 875)		800 / 70R38 (SRI 975)			800 / 70R38 (SRI 975)

6M 95 / 6M 105 / 6M 125		
623M	603R	623R
MSL	MSL	MSL
540/65R24		480/70R24
600/65R38		520/70R38
2,200 Standard	1,850 Standard	2,200 Heavy Duty
244	236	310
1,770	1,971	2,152
4,121	3,900	4,090
751	944	831
6.6	4.1	3.4

**NEED MORE
DETAILS?**

Visit the Frontloader section
of the John Deere website.

¹ Measured with flanged axle, up to cab roof, from front hydraulic to horizontal draft link hooks and with min. / max. front tyres, min. / max. rear tyre sizes.
² Measured at center of front axle, using max. front and max. rear tyre sizes.
³ Measured with average specifications.
 * Without cab suspension/ with cab suspension

SPECIFICATIONS

SMALL FRAME 6M				6M 110 / 6M 130		
LOADER MODEL				623M		
LEVELLING SYSTEM				MSL		
Front tyre				540/65R24		
Rear tyre				600/65R38		
LOADER						
Bucket				2,200 Standard		
Bucket Weight				kg	244	
Lift capacity @ full height	Measured @ 800 mm ahead of pivot	(V)	kg	1,765		
Maximum lift height				(A)	mm	4,120
Reach	@ Maximum height	(D)	mm	752		
Cycle times	Loader raise		sec	6.6		

MID FRAME 6M				6M 140 / 6M 155		
LOADER MODEL				643M		
LEVELLING SYSTEM				MSL		
Front tyre				480/70R28		
Rear tyre				580/70R38		
LOADER						
Bucket				2,200 Standard		
Bucket Weight				kg	244	
Lift capacity @ full height	Measured @ 800 mm ahead of pivot	(V)	kg	1,875		
Maximum lift height				(A)	mm	4,300
Reach	@ Maximum height	(D)	mm	638		
Cycle times	Loader raise		sec	4.7		

LARGE FRAME 6M				6M 180 / 6M 200 / 6M 220		
LOADER MODEL				663R	683R	
LEVELLING SYSTEM				MSL	MSL	
Front tyre				600/65R28		
Rear tyre				710/70R38		
LOADER						
Bucket				2,450 Heavy Duty		
Bucket Weight				kg	356	
Lift capacity @ full height	Measured @ 800 mm ahead of pivot	(V)	kg	2,352	2,506	
Maximum lift height				(A)	mm	4,520
Reach	@ Maximum height	(D)	mm	1,004	1,335	
Cycle times	Loader raise		sec	3.9	4.2	

EXTRA LARGE FRAME 6M				6M 230 / 6M 250		
LOADER MODEL				683R		
LEVELLING SYSTEM				MSL		
Front tyre				600/65R28		
Rear tyre				710/70R38		
LOADER						
Bucket				2,450 Heavy Duty		
Bucket Weight				kg	356	
Lift capacity @ full height	Measured @ 800 mm ahead of pivot	(V)	kg	2,538		
Maximum lift height				(A)	mm	4,520
Reach	@ Maximum height	(D)	mm	1,215		
Cycle times	Loader raise		sec	4.2		

The values may vary according to the tractor and loader settings/configuration.

6M 110 / 6M 130		
643M	623R	643R
MSL	MSL	MSL
540/65R24		480/70R24
600/65R38		520/70R38
2,200 Standard	1,850 Standard	2,200 Heavy Duty
244	236	310
1,918	2,272	2,330
4,159	4,124	4,151
920	759	982
4.5	3.4	3.3

6M 140 / 6M 155	
643R	663R
MSL	MSL
480/70R28	540/65R28
580/70R38	650/65R38
Heavy Duty 2,150 mm	Heavy Duty 2,450 mm
310	356
2,279	2,327
4,300	4,495
841	1,026
3.5	3.9

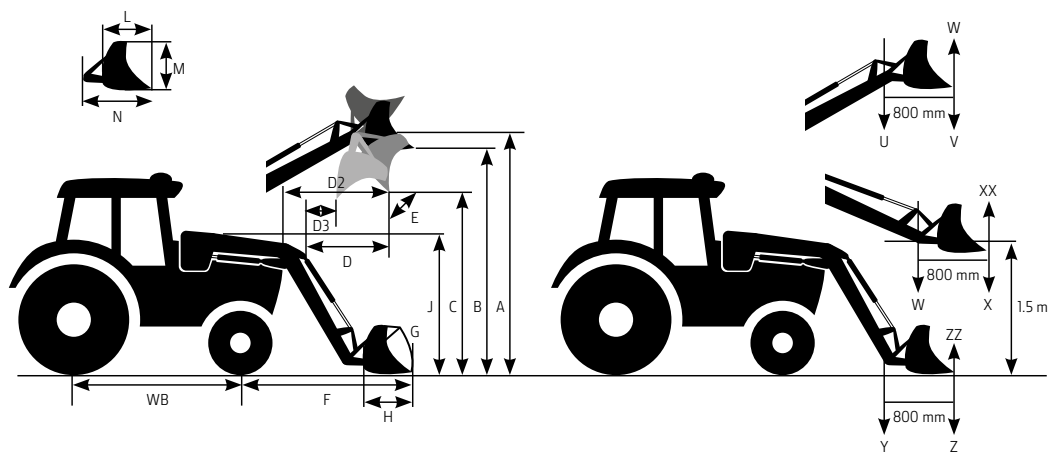

NOTHING RUNS LIKE A DEERE™

Chances are that when you need us, you need us right then and there. For advice, to solve a problem, or for a part. Reach out, we'll be there with technicians who are factory-trained, and ready to go to work for you, using only genuine John Deere parts and products. Our commitment to quality doesn't stop at your machine—we also have financing options available that are guaranteed to fit your budget and your plans.



This literature has been compiled for worldwide circulation. While general information, pictures and descriptions are provided, some illustrations and text may include finance, credit, insurance, product options and accessories NOT AVAILABLE in all countries or regions. In some countries, products and accessories may require modifications or additions to ensure compliance with the local regulations of those countries. PLEASE CONTACT YOUR LOCAL DEALER FOR DETAILS. John Deere reserves the right to change specification and design of all products described in this literature without notice. John Deere's green and yellow colour scheme, the leaping deer symbol, and JOHN DEERE are trademarks of Deere & Company. All photography and illustrations contained herein are copyrighted assets of Deere & Company.